

ALLEN&HEATH

CQ

User Guide
Firmware V1.1.0



1. Important Information	7
2. Introduction	8
The different models	8
Images and examples in this guide	10
3. Updating Firmware	11
Update firmware using the CQ-MixPad app	11
Update firmware using a USB drive	12
4. Connections	13
Power	13
1. Mic/Line Inputs	13
2. Outputs	14
3. Footswitch	14
4. USB and SD	15
5. Network Port	15
6. Built-In WiFi Access Point (CQ-18T, CQ-20B)	15
5. Connecting control apps	16
First connection to a CQ-20B	16
Connect using WiFi Access Point (CQ-18T, CQ-20B)	17
Connect using an external router or network	18
Connect a computer directly with a network cable	18
6. Operation and Workflow	19
Physical Controls (CQ-12T, CQ-18T)	19
CQ-MixPad	20
CQ4You	22
Workflow and main screens overview	23

Quick Start	24
Shows, Scenes and Libraries	26
Processing Copy, Paste and Reset	29
Processing Quick Fire	32
Convert a Quick Channel to a Complete Channel.....	33
7. How to...	34
Use Gain Assistant.....	34
Use Quick Channels.....	36
Send signal from Inputs to the Main Output.....	38
Send signal from Inputs to Outputs 1-6	40
Use the Feedback Assistant	42
Add and use FX.....	47
Send Audio to and from a DAW.....	50
Record/Playback Multitrack using an SD Card	53
Store and Recall settings.....	56
8. CONFIG	60
INPUTS.....	60
OUTPUTS.....	62
Digital Audio (Symbols) / USB/SD.....	64
Digital Audio (Symbols) / Bluetooth	66
AMM (Auto Mic Mixer).....	67
CONTROL & NETWORK / Footswitch	68
CONTROL & NETWORK / Soft Rotaries (CQ-18T).....	69
CONTROL & NETWORK / Soft Keys.....	70
CONTROL & NETWORK / Network (Ethernet)	71

CONTROL & NETWORK / Network (WiFi) (CQ-18T, CQ_20B)	72
9. PROCESSING	73
INPUTS (bank view)	73
INPUT / Quick Channels	75
INPUT / Preamp.....	79
INPUT / Gate.....	81
INPUT / PEQ.....	82
INPUT / Compressor.....	83
INPUT / Sends.....	85
ST. INPUTS / FX (bank view)	86
OUTPUTS (bank view).....	87
OUTPUT / GEQ.....	88
OUTPUT / PEQ	89
OUTPUT / FBA.....	90
OUTPUT / Compressor	93
OUTPUT / LEVEL and LIMITER.....	95
10. FADER	96
Sends to Main LR.....	96
Sends to an Output.....	97
Sends to FX	98
11. FX.....	99
CONTROL (Shared)	99
SENDS TO (Shared FX Units only)	101
CONTROL (Inserted).....	102
FX Model - Easy Verb	103

FX Model - Echo Verb	104
FX Model - Space Verb	105
FX Model – Echo.....	106
FX Model - Tap Delay	107
FX Model - Stereo Delay	108
FX Model - Beat Delay	110
FX Model - Double Tracker.....	112
FX Model – Chorus	113
FX Model – Flanger	114
FX Model – Phaser.....	115
12. HOME	116
Home (Symbol).....	116
RECORD / Stereo	117
RECORD / Multitrack.....	119
SCENES	122
DATA / Shows	123
DATA / Libraries.....	124
SYSTEM / Info	125
SYSTEM / USB/SD (Symbols).....	126
SYSTEM / Firmware	127
SYSTEM / Meters.....	128
SYSTEM / Preferences	129
13. Resets	130
CQ-12T and CQ-18T Factory Reset	130
CQ-20B Factory and Network Only Resets	130

Default Network Settings	131
14. System Block Diagram.....	132
15. Specifications	133
16. Warranty Information	136

1. Important Information

Safety

Before powering on the CQ, read the safety instructions sheet (004-1511-01 or 004-1512-01) supplied with the unit. For your own safety and that of the operator, technical crew and performers, follow all instructions and heed all warnings included in these documents and those printed directly on the equipment.

Ventilation

Do not obstruct any of the air vents when in use. Adequate ventilation is especially required for the cooling fan found on the bottom of the CQ-18T and CQ-12T, and the side of the CQ-20B.

Updates to this user guide

This user guide is intended to be used and distributed in a digital format; it may be up issued at any time. Always ensure you are referring to the latest version which matches the firmware version being used, and avoid printing a hard copy wherever possible.

Registration

To be kept informed of updates, the latest firmware and new releases for the CQ range, register your CQ at <http://www.allen-heath.com/myCQ>

Support

For further support with CQ, please visit support.allen-heath.com, or contact your local distributor.

Firmware updates and apps

Visit www.allen-heath.com/myCQ to obtain the latest version of firmware and ensure you are registered to receive notifications on future updates.

The firmware on the CQ and all app versions must have the same major release number. This is the first two digits of each release number.

Firmware **V1.1.3** and App **V1.1.5** = compatible

Firmware **V1.1.3** and App **V1.2.3** = not compatible

2. Introduction

Welcome to the CQ User Guide.

CQ is a range of portable, standalone digital audio mixers which use 96kHz processing and include assistants and tools designed to be used by technical and non-technical users alike.

There are 3 models in the range, two with hands-on control, and all of which can be controlled remotely. All have a similar set of features and specifications, with differences in I/O, channel count and control options.

The different models

	CQ-12T	CQ-18T	CQ-20B
Mic/Line Inputs	5x XLR 5x 'Combi' XLR/TRS	8x XLR 8x 'Combi' XLR/ TRS	8x XLR 8x 'Combi' XLR/ TRS
Stereo Line Inputs	1 (2x Balanced TRS)	1 (2x Balanced TRS)	2 (4x Balanced TRS)
Main Outputs	2x XLR	2x XLR	2x XLR
Monitor/Aux Outputs	6x Mono Balanced TRS	6x Mono Balanced TRS	6x Mono Balanced XLR
Headphone Outputs	1x ¼" TRS	2x ¼" TRS	1x ¼" TRS
Touchscreen	7" Multi-Touch	7" Multi-Touch	-
SoftKeys	3	3	-
Soft/Smart Rotaries	-	3	-
FX Engines	2	4	4

CQ-18T Hardware Overview

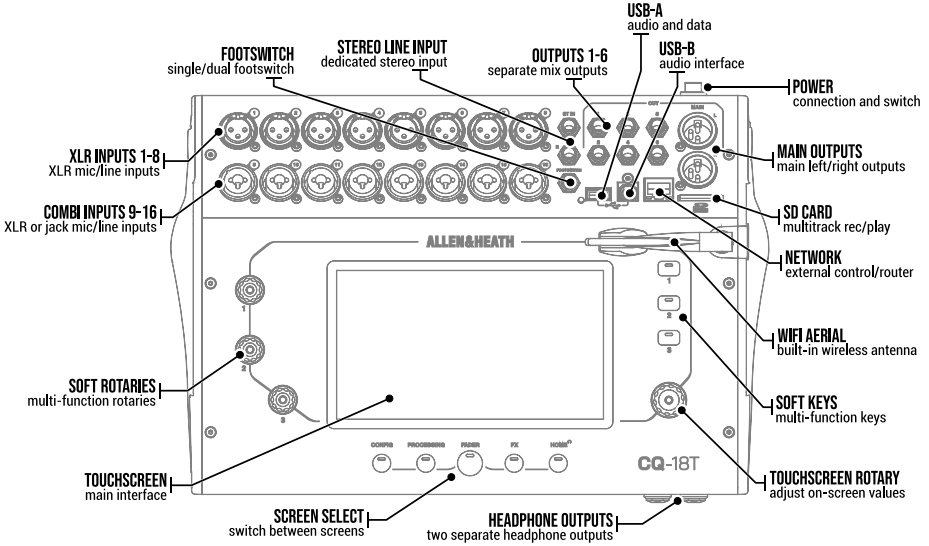

CQ-12T Hardware Overview

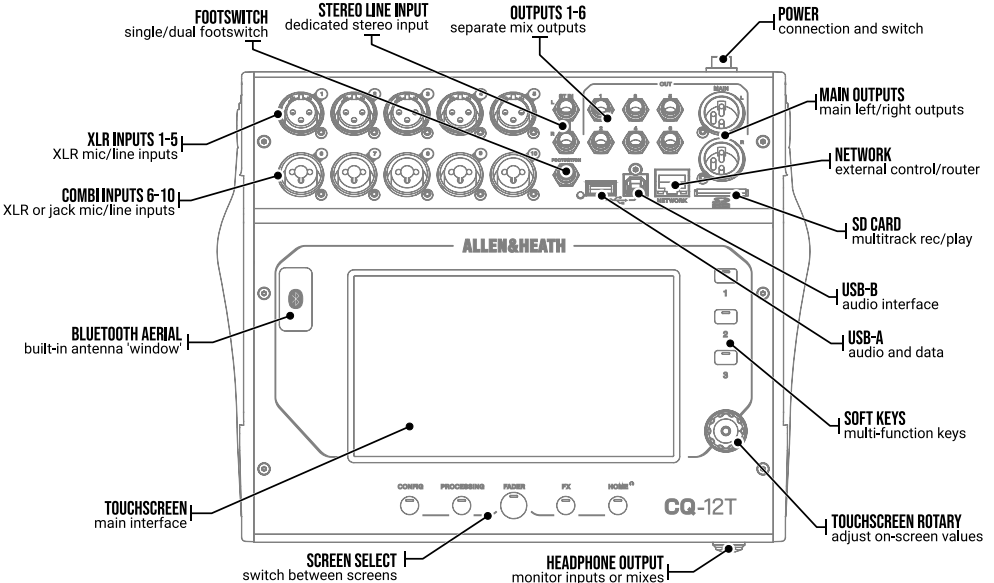

CQ-20B Hardware Overview

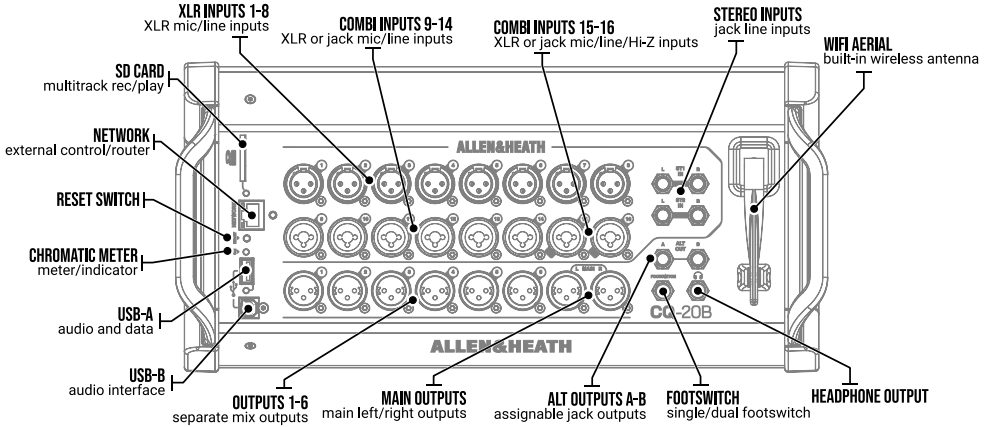

Images and examples in this guide

This guide uses screenshots from the CQ-18T, which includes all the features of the CQ-12T and more.

CQ-MixPad, used to control all models, has an almost identical user interface with a few layout differences (listed in the [CQ-MixPad](#) section of this guide) and so is not shown in addition.

Features specific to any model or interface are noted.

3. Updating Firmware

There are two methods for updating CQ firmware, either with the CQ-MixPad app (available for iOS, Android, Mac and Windows) or by using a USB drive connected to the USB-A port.

Updating firmware (from V1.1.0 onward) will not clear or delete data, but it is best practice to store a show before carrying out an update if possible.

- ❗ CQ's manufactured before September 2023 were loaded with firmware V1.0.1. Data stored using this version is incompatible with later firmware. A [full reset](#) should be carried out after the first firmware update.

Update firmware using the CQ-MixPad app

1. Download the latest version of the app. iOS and Android versions are available from the App Store and Play Store. Mac and PC versions are available from [allen-heath.com](https://www.allen-heath.com).
2. Connect CQ-MixPad to the CQ (see the [App Setup](#) section)
3. If an update is required, the app will provide details and instructions on screen, with an option to begin the update process.
4. Confirm the update on the CQ.
5. Restart the CQ.
6. Check that the new version has installed correctly by looking at **Current:** in the **HOME / SYSTEM / Firmware** tab, or find the **Firmware Version:** listed in the **HOME / SYSTEM / Info** tab.

Update firmware using a USB drive

1. Insert a new or FAT formatted USB drive into the CQ's USB-A port.
2. Press the **HOME** screen key and select **SYSTEM** then the USB/SD tab (with USB and SDHC symbols).
3. Press the **Format** button in the USB Status section on the left and follow the on-screen instructions to format the drive, this will clear all data and set up any necessary folder structure for use with CQ.
4. Once formatted remove the drive and connect to a Windows or Mac computer.
5. Download the latest version of firmware from <http://www.allen-heath.com/mycq> ensure that the correct version of firmware is downloaded for the model being updated.
6. Unzip/expand the downloaded ZIP file and copy the firmware file (which has a .bin suffix) to the root of the USB drive, do not place it in any of the folders.
7. Ensure there is only one version of firmware on the USB drive at any one time. Delete all old versions before copying new ones.
8. Safely eject the drive and re-insert into the CQ.
9. Go to the CQ's **HOME** screen, select **SYSTEM** and then **Firmware**.
10. This screen will display the firmware the unit is currently running at the bottom and the firmware found on the connected USB drive at the top. Touch the **Update** button to begin the update process.
11. Follow the on-screen instructions and touch the **Restart** button when prompted to reboot the CQ and complete the firmware update.
12. Check that the new version has installed correctly by looking at **Current:** in the **HOME / SYSTEM / Firmware** tab, or find the **Firmware Version:** listed in the **HOME / SYSTEM / Info** tab.

4. Connections

Power

CQ-12T, CQ-18T

12VDC, 5A, centre positive connection and clip. Use supplied external switching power supply with IEC connection to mains.

CQ-20B

IEC connection with internal switch mode power supply.

1. Mic/Line Inputs



Mono Inputs 1-5 (CQ-12T) and 1-8 (CQ-18T, CQ-20B)

Balanced XLR (1-Ground, 2-Hot/Positive, 3-Cold/Negative), recallable preamp with +60dB gain and phantom power.



Mono Inputs 6-10 (CQ-12T) and 9-16 (CQ-18T, CQ-20B)

Balanced XLR (1-Ground, 2-Hot/Positive, 3-Cold/Negative) Or ¼" TRS Jack (Tip-Hot/Positive, Ring-Cold/Negative, Sleeve-Ground)



Mono Inputs 15-16 (CQ-20B) - switched to Hi-Z mode

¼" TS Jack (Tip-Hot/Positive, Sleeve-Ground)

Mono inputs include recallable preamp with +60dB gain, fixed -20dB pad on TRS input, phantom power supplied to XLR connection only.



Stereo Line Inputs

2x ¼" TRS Jack (Tip-Hot/Positive, Ring-Cold/Negative, Sleeve-Ground)

Stereo input connections are normalised (L/M, R), connect mono signals to left socket only. Digital trim control available in processing channel.

2. Outputs



Main LR

Balanced XLR (1-Ground, 2-Hot/Positive, 3-Cold/Negative)

Nominal +4dBu output (when output meter displays 0dB)



Out 1-6 (CQ-12T, CQ-18T)

Balanced 1/4" TRS Jack (Tip-Hot/Positive, Ring-Cold/Negative, Sleeve-Ground)

Nominal +4dBu output (when output meter displays 0dB)



Out 1-6 (CQ-20B)

Balanced XLR (Pin1-Ground, Pin2-Hot/Positive, Pin3-Cold/Negative)

Nominal +4dBu output (when output meter displays 0dB)

Headphone/s

Stereo 1/4" TRS Jack (Tip-Left, Ring-Right, Sleeve-Ground)

Recallable digital trim control.

3. Footswitch



Mono (TS) or Dual (TRS) 1/4" Jack

Can be calibrated for use with momentary or latching switches.

4. USB and SD



USB-A (CQ as host, for audio and data storage and recall)

USB-B (CQ as client, for audio only).

Conforms to USB 2.0 standard. Class compliant USB-B interface.



Full size SD card slot. Use SDHC, Up to 32GB, UHS-I, Class 10.

5. Network Port



RJ45, Fast Ethernet. For network control messaging only.

6. Built-In WiFi Access Point (CQ-18T, CQ-20B)



Dual band (2.4GHz or 5GHz), Auto Channel sensing.

5. Connecting control apps

The CQ-MixPad app provides full remote control of the CQ over a network connection from an iOS, Android, macOS or Windows device.

CQ4You is an easy-to-use personal monitoring app, which also works over a network, and controls the send levels to one of the outputs.

Up to 2 instances of CQ-MixPad can be connected to a CQ at once, along with up to 6 instances of CQ4You (one for every output).

Note that only control messaging is shared over the network connection between the CQ and any connected app, no audio is transmitted or received. To send audio wirelessly from a device to the CQ, the Bluetooth connection can be used.

 Remote control of the CQ is not possible via Bluetooth.

The firmware on the CQ and all app versions must have the same major release number. This is the first two digits of each release number.

Firmware V1.1.3 and App V1.1.5 = compatible

Firmware V1.1.3 and App V1.2.3 = not compatible

First connection to a CQ-20B

- 1) After booting, the Chromatic Meter (CM) LED will flash to show the enabled network, if not, carry out a [network or full reset](#) of the unit.
- 2) Press the reset button to toggle between the two options.
 - flashing BLUE ● = **Wi-Fi** enabled with [default settings](#)
 - flashing YELLOW ● = **Ethernet** enabled with [default settings](#)

 The Chromatic Meter (CM) LED will continue to flash until a network has been set up and secured.

- 3) Connect the device running CQ-MixPad to either the built-in Wi-Fi, to the same network as the CQ is connected to, or connect directly to the CQ using a network cable.
- 4) Complete the setup of the network as described in the rest of this section.

Connect using WiFi Access Point (CQ-18T, CQ-20B)

- 1) Navigate to **CONFIG / CONTROL & NETWORK / Network**
- ❗ If there is already a connection to the CQ-20B, otherwise follow [First connection to a CQ-20B](#).
- 2) Switch **Enabled Network** to **WiFi Access Point**
- 3) Setup the network. Recommended settings are:
 - WPA2 Password on
 - WPA2 Password set (change from default 'DefaultPassword')
 - Frequency dependent on environment and other equipment
 - Channel set to Auto
 - SSID Hidden (once all devices have connected and stored network details)
- 4) Note the network name and password.
- 5) Apply any changes.
- 6) Connect the remote device to the Wi-Fi network that's just been set up.
- 7) Run CQ-MixPad or CQ4You and connect to the CQ from the Choose Unit list.
- ❗ If the unit does not appear in the choose unit list, try selecting 'Other' and entering the IP address manually. The current IP address of the unit is listed in the **HOME / SYSTEM / Info** screen.

Connect using an external router or network

- 1) Connect the CQ to the external router or network as a client, using a network cable connected to the network port. Follow instructions on any router or access point as if the CQ were a computer (e.g. connect to a LAN port).
- 2) Navigate to **CONFIG / CONTROL & NETWORK / Network**
- 3) Switch **Enabled Network** to **Ethernet** (CQ-18T, CQ-20B)
- 4) Setup the network. It is recommended that IP Mode is set to Automatic, to allow automatic address assignment via DHCP where possible. Setting IP Mode to Manual should only be required where a DHCP host is not available, or for setups where an IT or networking team needs to allow access.

i When IP Mode is set to Automatic and no IP address is provided to the CQ, it will auto assign itself an address. This is noted by a (*) appearing after the address in the network config and system information screens.

i If IP Mode is set to Manual and the change is applied before editing the address, gateway and subnet, the defaults can be found in the [Default Network Settings](#) section of this guide.

- 5) Connect a device to the same router, access point or network.
- 6) Run CQ-MixPad or CQ4You and connect to the CQ from the Choose Unit list.

Connect a computer directly with a network cable

- 1) Navigate to **CONFIG / CONTROL & NETWORK / Network**
- 2) Switch **Enabled Network** to **Ethernet** (CQ-18T, CQ-20B)
- 3) Set IP Mode to Automatic and apply to let the CQ self-assign an address.
- 4) Connect the device running CQ-MixPad directly via the network port.
- 5) Run CQ-MixPad and connect to the CQ from the Choose Unit list.

6. Operation and Workflow

Physical Controls (CQ-12T, CQ-18T)

Screen keys

5x Keys for navigation between the main **CONFIG**, **PROCESSING**, **FADER**, **FX** and **HOME** screens.

- Screens have persistence, other than for channel selection, which is followed across **CONFIG**, **PROCESSING** and **FADER** screens.
- Screen keys can be pressed multiple times in some screens:
 - In HOME to return to the home tab and control headphone level.
 - In PROCESSING to exit a processing view and return to bank view.

Soft Keys

3x Custom keys that can be set to control tap tempos, mutes, scene controls and recording amongst many other functions.

Touchscreen and touchscreen rotary control

7" capacitive multi-touch screen. Touch and drag on-screen to control faders. Touch a parameter on screen and use the touchscreen rotary control to adjust. The touchscreen rotary and parameter will illuminate yellow to indicate control.

Soft Rotaries / Smart Rotaries (CQ-18T)

3x Rotary controls with RGB illumination that can be set to control levels and processing parameters for a specific channel or the currently selected channel.

Smart Rotaries mode assigns parameters to the rotaries depending on the current screen. For example, in input bank view, the rotaries will control Gain, Pan and send level. With a compressor on screen, they instead control Ratio, Threshold and Gain.

Coloured dots in the controls on screen match the Smart Rotary illumination to indicate which parameters are linked.

The CQ-MixPad app has been designed to have an almost identical interface to the touchscreen on the CQ-12T and CQ-18T.

CQ Touchscreen (Processing bank view)



CQ-MixPad (Processing bank view)

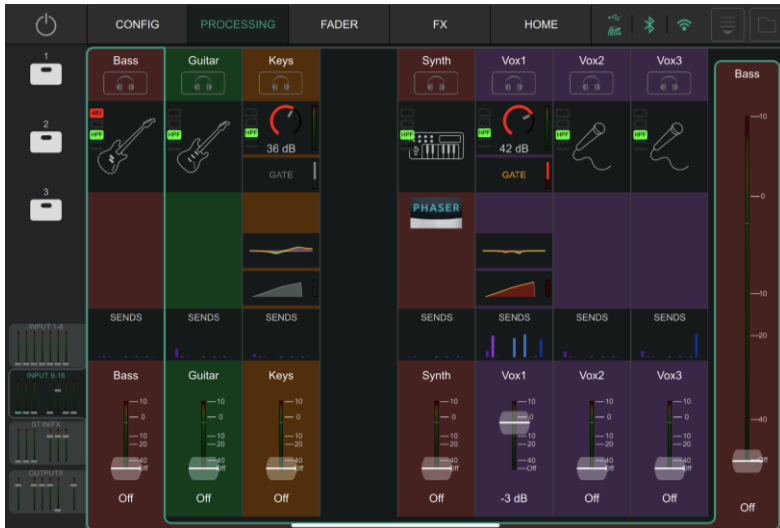

Differences

1. Main screen keys:
Physical keys on hardware Vs Main tabs at the top of CQ-MixPad
2. Soft Keys:
Physical keys on hardware Vs buttons on CQ-MixPad
3. Location of channel bank tabs:
At the top of a CQ touchscreen Vs At the bottom left of CQ-MixPad
4. Keyboard text entry:
On-screen with hardware Vs Default method for the remote device

Some additions with CQ-MixPad are:

5. Faders are available at the bottom of Processing and FX screens.
6. Other than in the Processing screen, output selection and output level fader are always available on the right-hand side.

Control and fine adjustment of faders in CQ-MixPad

Touch or click and drag to move faders up or down.

Keep the fader selected (keep finger on screen or click and hold) and move left or right away from the fader to make finer adjustments when moving up or down. The further from the fader, the finer the control.

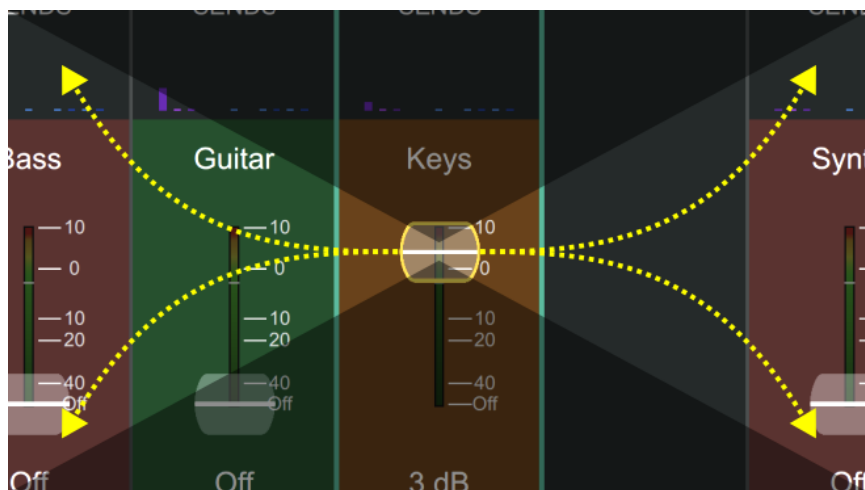

Adjustment of processing parameters in CQ-MixPad

Touch or click and drag left and right on complete channel processing parameters to adjust.

Keep the control selected (keep finger on the screen or click and hold) and move up or down away from the parameter for finer adjustments when moving left or right. The farther from the parameter, the finer the adjustment.

Control of Quick Channel and FX parameters

These (generally larger) controls do not offer fine control and are designed to be adjusted using both left/right *and* up/down gestures.

CQ4You

The CQ4You app allows each musician or performer to control only the send levels to their own monitor out.



The main screen displays the overall output level on the right, with the ability to select the output being controlled above this, and a mute at the bottom.

To the left are 4 groups with control wheels, which are used to adjust the send levels for all channels assigned to it simultaneously. Meaning, for example, that all the drums in the monitor can be turned up or down at the same time.

Double tap a wheel to rename it, assign channels to it and make individual send level adjustments for all assigned channels in the group.

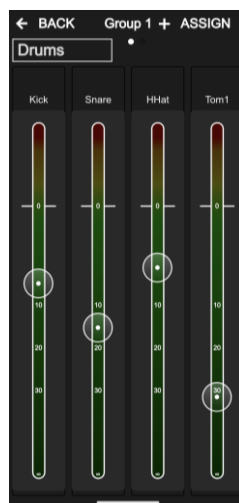

Workflow and main screens overview

The CQ UI has been designed for fast operation during mixing and with a logical layout for setup. Common mixing functions appear in the middle 3 screens, with the idea that the user ‘works in’ from the **HOME** and **CONFIG** screens during setup, and then switches between **PROCESSING**, **FADER** and **FX** screens when mixing.

The basic intended workflow is as follows:

HOME – Set/check headphone level and use Quick Start to recall a template if required. Recall a scene or data as a starting point. Return to the home screen for headphone level adjustment, or if carrying out system functions (e.g. recording or formatting media, or setting system preferences).

CONFIG – Initial configuration of the mixer *before* mixing. Work from left to right at the bottom of the screen on a channel-by-channel basis to set name and colour, recall channel libraries and to set gains on inputs or delays on outputs. Configure USB patching and Bluetooth connection, switch AMM on/off, set up physical and remote control (network setup for app control).

PROCESSING – Adjust processing on a channel-by-channel basis. This screen is about looking at each channel individually, including seeing SENDS from each channel to all possible output and FX destinations. Touch a channel once to select it, then touch any processing ‘block’ to make adjustments.

FADER – Adjust signal being sent to a selected output or FX (by default input levels going to Main LR). Includes control of overall level to output sockets and access to input and output mutes. In the opposite way to the PROCESSING / SENDS screen, which shows one source going to multiple destinations, the FADER screen shows multiple sources to one destination.

FX – Adjust FX parameters as required. Recall different FX models to each FX unit. Use the SENDS TO screen (for FX in shared mode) to see all channels using that FX unit. Quickly mute all FX between songs.

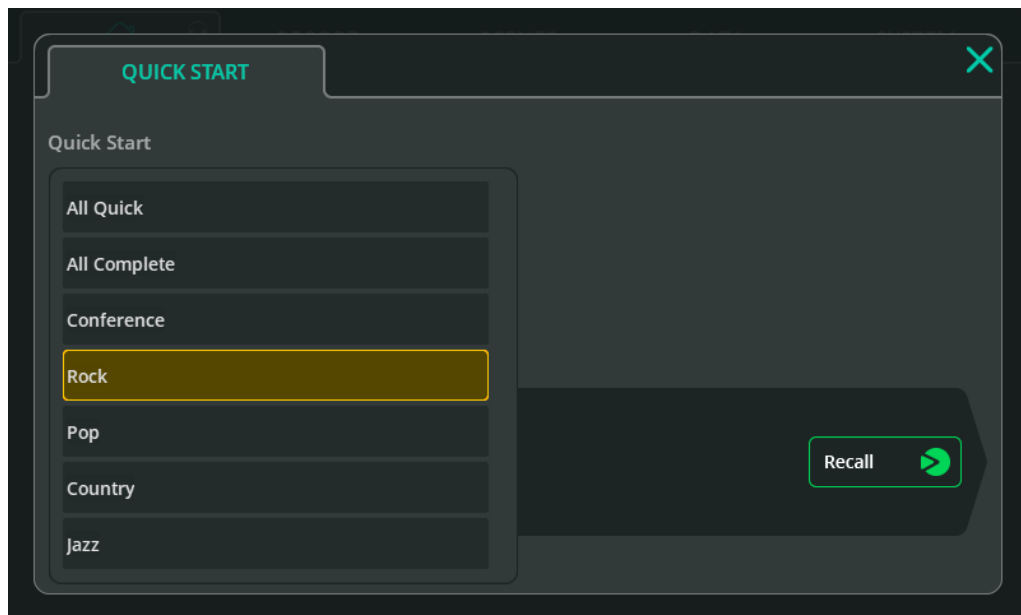

The Quick Start button (in the first **HOME** screen tab) opens a list of factory templates for use as the starting point for some typical mixer applications.

Recalling a Quick Start template will set all **CONFIG**, **PROCESSING** and **FX** screen parameters, including input and output channel linking, naming and colour along with all processing and FX units.

The Quick Start workflow is:

1. Recall a Quick Start template
2. Go to the **CONFIG** screen to make any adjustments to the setup and set input gains (using Gain Assistant)
3. Raise levels in the **FADER** screen
4. Make changes to the mix using the **PROCESSING**, **FADER** and **FX** screens

Once the template has been adjusted to suit, it can then be stored as a Scene or into a Show for future use.

Important things to be aware of when using Quick Start:

- The current state of the CQ will be overwritten, so it's good practice to store a Scene *before* recalling a Quick Start template.
- Unlike a Scene, Quick Start can change stereo linking of inputs and outputs and EQ Type. This can mean that recalling Scenes *after* recalling a Quick Start template results in an unexpected setup. To correct an issue due to different configurations, reset stereo linking and EQ Types to the correct state and recall the Scene again.
- Preamp Gain settings will be set to 0dB and all +48V Phantom Power will be turned off.

Templates

All Quick – All linkable channels set to mono. All mono and stereo inputs have the EasyEQ Quick Channel running (and flat) for simple, quick control of any input source type.

All Complete – All linkable channels set to mono. All mono and stereo inputs have a Complete Channel recalled with all processing blocks fully reset.

Conference - All linkable channels set to mono. First bank of inputs use Voice Quick Channels. All other mono and stereo inputs use EasyEQ Quick Channel (set flat).

- ❗ Turn the Automatic Microphone Mixer On for each voice channel being used in the **CONFIG / AMM** screen.

Rock* – Inputs set for Drums, Bass, Rhythm Guitar, Lead Guitar and Vocals, all using Quick Channels.

Pop* - Inputs set for Drums, Bass, Guitar, Keys, Synth and Vocals, all using Quick Channels.

Country* - Inputs set for Drums, Bass, Keys, Acoustic Guitar, Electric Guitar, Banjo, Fiddle, Harmonica and Vocals, all using Quick Channels.

Jazz* – Inputs set for Drums, Bass, Piano, Guitar, Saxophone, Trumpet and Vocals, all using Quick Channels.

*These templates vary depending on CQ model being used.

Shows

The CQ has one 'Show' running on it at any time. A Show includes the current state of the mixer, the current mixer config, mixer preferences, up to 100 Scenes and up to 128 Library items.

Shows are used for different setups and applications and therefore recall more settings than a Scene, including stereo linking of channels, Output EQ Type and brightness settings for screens or LED's.

However, Shows do *not* include network settings, unit name, stored Bluetooth connections, or USB/SD settings. These are set per unit, so that network settings on a venue's mixer are not overwritten when a visiting engineer recalls a Show!

Multiple Shows can be stored and recalled using a USB storage device (e.g. a USB stick drive).

Scenes

Scenes allow instantaneous storage and recall of multiple parameters and settings at once. They store/recall the *mix state* of the CQ and can be used for the different scenes of a theatre production (hence the name), different songs in a set, or even different bands at a show if the setups are similar.

The CQ has 100 Scene slots available (per show). A Scene stores all preamp, channel naming, processing parameters, send levels, FX units and parameters and Soft Key and Soft Rotary assignments.

Libraries

Libraries are used throughout the CQ to store and recall parameters for channels or processing.

The button to open the library can be found in the **CONFIG, INPUTS** and **OUTPUTS** screens, the top right-hand corner of most **PROCESSING** screens and the **FX** screen.

A different library is opened depending on which screen is being viewed.

Stored in the CQ

- 1 **Show**
- Network settings
- Unit name
- Factory Libraries

Stored in each Show

- 100 **Scenes**
- 128 User Libraries
- Input/Output Stereo Linking
- USB source and sample rate
- Surface brightness preferences
- Chromatic Metering settings
- Headphone Level

Stored in each Scene

- Input Source
- Preamp/Trim settings
- Input processing
- Send levels and panning
- Channel names and colours
- Channel mutes
- FX units and parameters
- SoftKey/SoftRotary assignments
- Footswitch settings
- AMM settings

Available Libraries

- i** All Libraries are displayed as a pop-up, accessed using the Library button in the screen listed in brackets here. Libraries affect the selected channel or processing being viewed.

Whole Input Channel (CONFIG / INPUTS)

Includes: Input name/colour, preamp/trim settings, Quick Channel or Complete Channel (HPF, Gate, PEQ, Compressor)

Input Channel Processing (PROCESSING / INPUTS (bank view))

Includes: Quick Channel, Complete Channel (HPF, Gate, PEQ, Compressor)

Input Channel Processing (PROCESSING / INPUT / Quick Channel)

Includes: Quick Channel or Complete Channel (HPF, Gate, PEQ, Compressor)

Whole Output Channel (CONFIG / OUTPUTS)

Includes: Output name, EQ Type, GEQ or PEQ+FBA, Compressor, Limiter

Output Channel Processing (PROCESSING / OUTPUTS (bank view))

Includes: EQ Type, GEQ or PEQ+FBA, Compressor, Limiter

Gate (PROCESSING / INPUT / Gate)

Includes: Gate settings only

GEQ (PROCESSING / OUTPUT / GEQ)

Includes: GEQ settings only

PEQ (PROCESSING / INPUT / PEQ and PROCESSING / OUTPUT / PEQ)

Includes: PEQ settings only

Feedback Assistant (PROCESSING / OUTPUT / FBA)

Includes: FBA settings and Fixed Mode filters only

Compressor (PROCESSING / INPUT / Compressor and PROCESSING / OUTPUT / Compressor)

Includes: PEQ settings only

Limiter (PROCESSING / OUTPUT / Limiter)

Includes: Limiter settings only

FX (FX)

Includes: FX model, FX parameters, FX Unit Mute Mode, Insert Mix%

Processing Copy, Paste and Reset

Copy

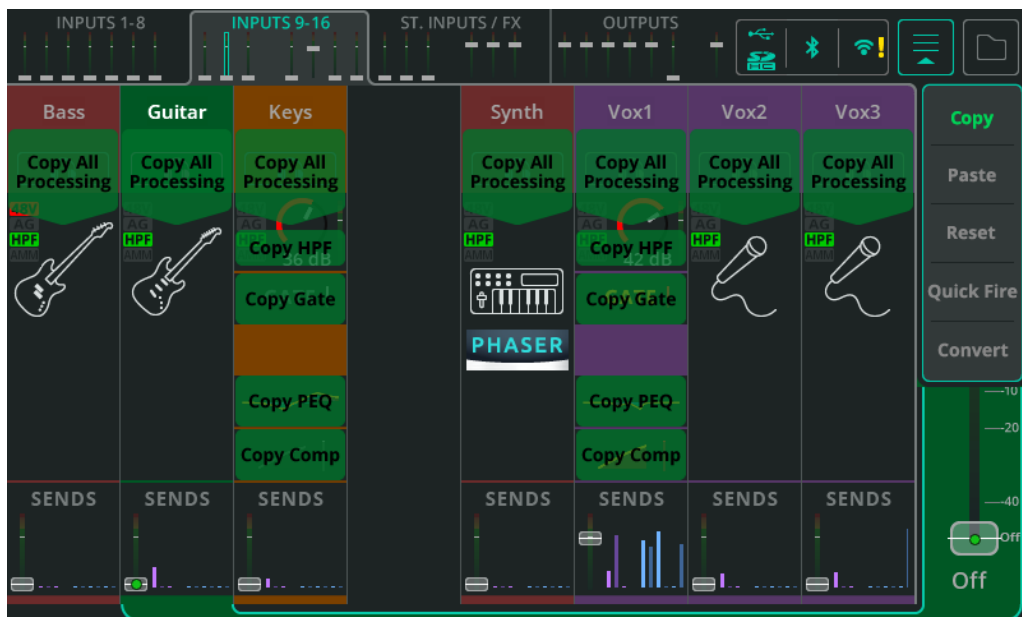

Open the dropdown menu from the top right-hand corner and select **Copy** to see the available processing to Copy.

Copying can be carried out in the bank view (as shown), but also when viewing individual processing.

Touch any of the options to copy the processing. The copied processing block or channel will be indicated with a lighter green.

Paste

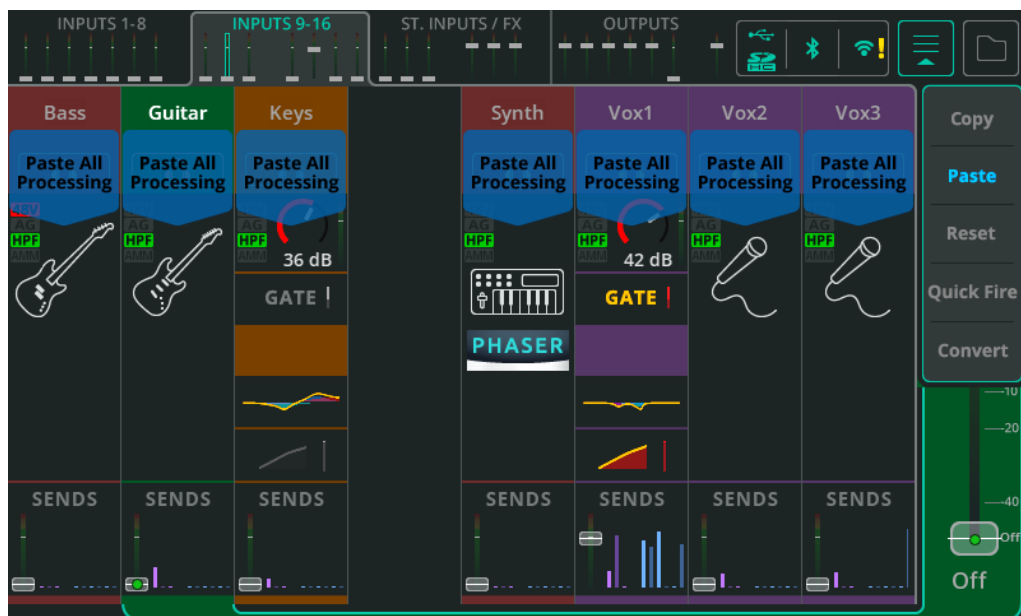

Open the dropdown menu from the top right-hand corner (if not already open from copying) and select **Paste** to see the available places any copied processing can be pasted

Touch any of the options to paste the processing. Any processing block or channel where processing has been pasted will be indicated with a lighter blue.

Pasting can be carried out in the bank view (as shown), but also when viewing individual processing.

Reset

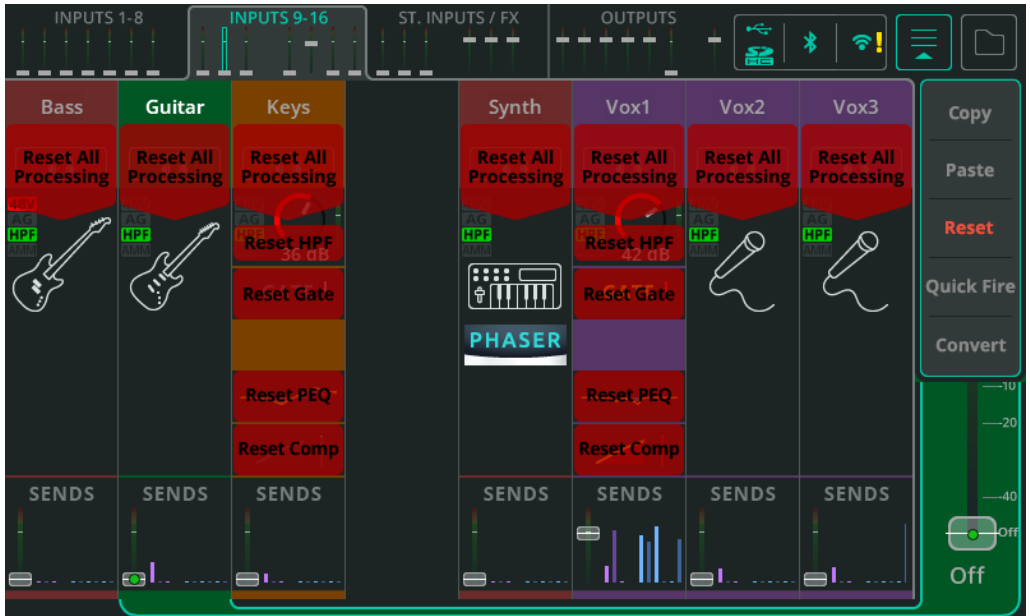

Open the dropdown menu from the top right-hand corner and select **Reset** to see the available reset options.

Touch any of these options to reset processing to default values.

Resets can be carried out in the bank view (as shown), but also when viewing individual processing.

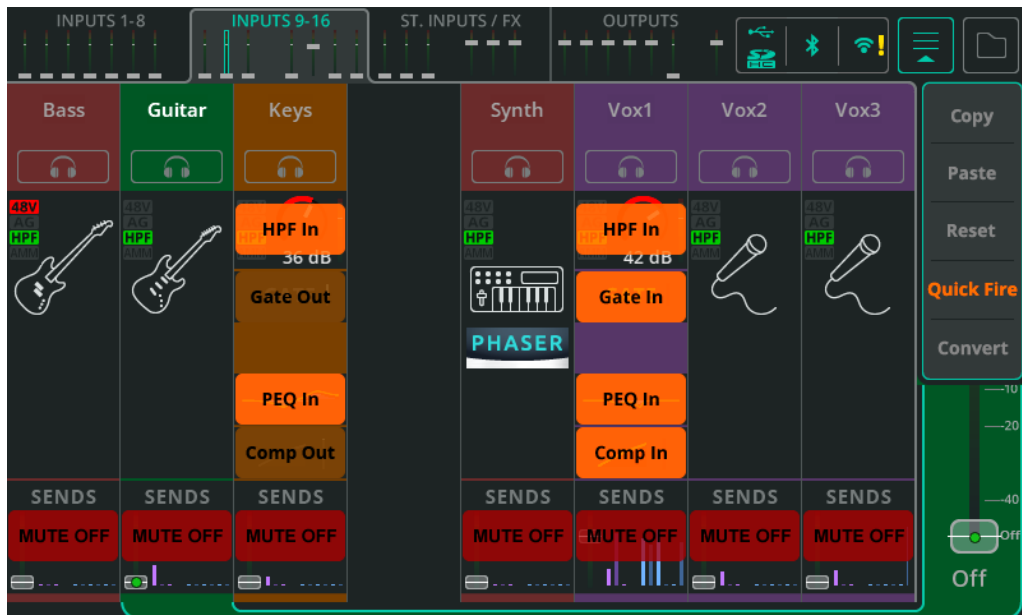

Open the dropdown menu from the top right-hand corner when in a bank view and select **Quick Fire** to view an overlay which allows processing to be quickly switched in or out across all visible complete channels.

Quick Fire also allows channels to be muted from within the **PROCESSING** screen.

Convert a Quick Channel to a Complete Channel

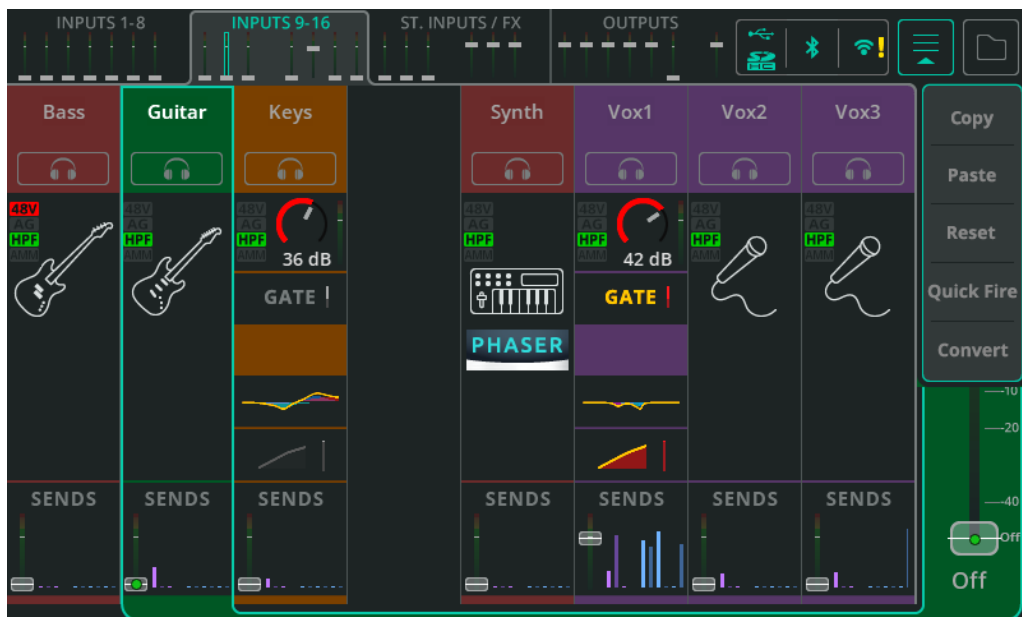

Any Quick Channel can be converted to a Complete Channel at any time without any change to the audio.

This allows Quick Channels to be used for a fast setup, but which can then be switched to Complete Channels for control of individual parameters if desired.

Open the dropdown menu from the top right-hand corner when in a bank view with the Quick Channel selected, or when viewing the Quick Channel controls of the channel to be converted, then select **Convert**.

A pop-up explaining what will happen will appear and give the option to apply or cancel conversion.

Note that it is not possible for Complete Channels to be converted to Quick Channels.

7. How to...

Use Gain Assistant

Gain Assistant can be used on any input channel which has a preamp, when the Input Source is set to Analogue.



1. Connect a source (e.g. Microphone) to input socket 1-10 (CQ-12T) or 1-16 (CQ-18T, CQ-20B).



2. Go to **CONFIG / INPUTS** and select that input socket. Settings will appear in the bottom half of the screen.

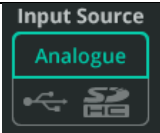

3. Ensure the **Input Source** is set to **Analogue**.



4. If using a source that requires 48V phantom power, such as a condenser microphone or active DI box, ensure this is turned on.

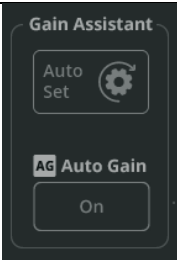

5. In the **Gain Assistant** section, use the **Auto Set** button to begin setting preamp gain.

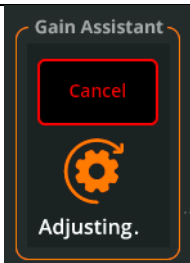

6. Make noise into the connected microphone or with the connected instrument/source to let the Gain Assistant know what the typical signal level will be.

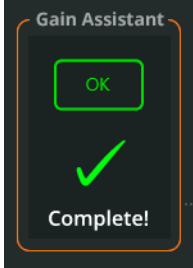

7. Gain Assistant will automatically raise the Gain and set the optimum input level.

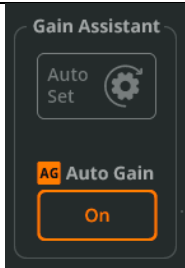

8. Once the **Auto Set** function is complete, the **Auto Gain** feature will be enabled. The input is now ready for processing and recording or adding to a mix.

i Gain Assistant can also be found in the **PROCESSING / Preamp** section of a Complete Channel.

Auto Gain

This can be used independently of Auto Set and turned on or off at any time. Auto Gain constantly checks the input signal level in the background and if the preamp gain is set too high (e.g. an instrument or voice get louder than they were during sound check), it will reduce gain until the signal is back to an optimum level.

Multi Select

Use Gain Assistant functions on multiple preamps at the same time with **Multi Select** by simply turning it on and then selecting the desired channels; Input Source and Gain Assistant settings will then be available at the bottom of the screen.

Use Quick Channels

Quick Channels are instrument or source-centric whole channel presets which allow the user to mix quickly by adjusting multiple parameters with just a few controls. They are useful for non-technical users who don't want to get lost in menus and parameter values, but also for more technical users who need to work fast but may want to make more in-depth adjustments later.



1. Go to **CONFIG / INPUTS** and select an input socket. Settings will appear in the bottom half of the screen.

OR

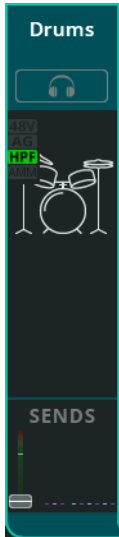

1. Go to **PROCESSING / INPUTS** and select an input channel in bank view (when multiple channels are visible).

Be sure to *only* touch or click once to select a channel so the screen remains in bank view.

- ❗ Recall a channel from the CONFIG screen to include name/colour and preamp settings. Recall from the PROCESSING screen to include only the processing and leave the name/colour and preamp settings as they were.

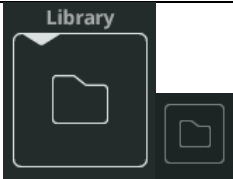

2. Open the **Library** pop-up with the Library button at either bottom left (CONFIG), or top right (PROCESSING).



3. Select the **Quick** tab to list only Quick Channels.

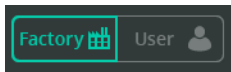

4. Switch to Factory to show the built-in factory options.

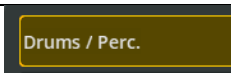

5. Choose and recall a Quick Channel according to the type of instrument/source being used. Each of the Factory options is a different Quick Channel and most include several variants when recalled too.



5. In the **PROCESSING** screen, view the Quick Channel controls by selecting the channel and then touching or clicking on the Quick Channel icon.



6. If headphones are connected and the source set to the default 'Listen' option, use the **Listen** button (with headphone symbol) to hear only the audio from the current channel.

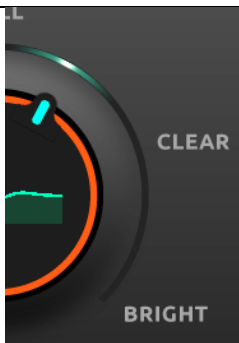

7. Each Quick Channel is created for a source type and includes a few controls. Examples can be seen in the [INPUT / Quick Channels](#) section of this guide.



8. When happy with the sound, select **SENDS** from the right-hand side navigation strip to view and adjust the levels being sent to FX Units and Outputs.

i As listed on-screen under the recall section when viewing the Library pop-up - recalling from the CONFIG screen will include input Name, Colour and Preamp settings, whereas from the PROCESSING screen, it includes only processing.

Send signal from Inputs to the Main Output

Prior to sending signal anywhere, preamp gain or trim should be set correctly for the input source. Follow the [How to Use Gain Assistant section](#) for best results.

This ensures optimum signal level coming into the channel for processing, but more importantly when thinking about sending (routing) signals, changing the preamp gain or trim also affects the level of signal being sent to any outputs.

Send one input at a time using the PROCESSING screen



1. Go to **PROCESSING / INPUTS** and select the channel to be sent to the Main LR output.

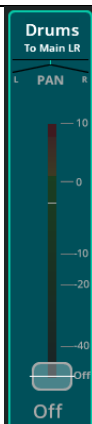

2. Use the fader on the right-hand side to adjust the send level for just the selected channel. Touch/Click and drag, or select the fader and use the Touchscreen rotary control (CQ-12T, CQ-18T).

 Repeat steps 1 and 2 for other inputs as required.



3. Adjust the (overall) Main LR output level by going to the **OUTPUTS** tab, selecting the Main LR output channel, and again using the fader on the right-hand side.

Send multiple inputs to one output using the FADER screen

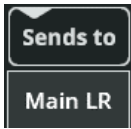

1. Go to the **FADER** screen and check that the fader on the right-hand side is labelled 'Main LR'. If not, use the **Sends to** button to show all available 'Send to' destinations and select **Main LR**.

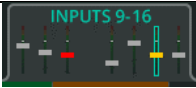

2. Use the tabs at the top of the screen to navigate between banks of Inputs.

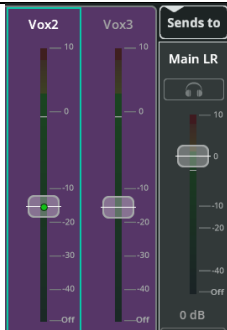

3. Raise the fader for any Input (or multiple inputs) to send signal from input channel to the Main LR output. Touch/Click and drag, or select the fader and use the Touchscreen rotary control (CQ-12T, CQ-18T).

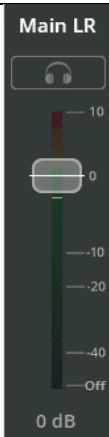

4. Adjust the (overall) Main LR output using the fader on the right-hand side.

Send signal from Inputs to Outputs 1-6

Prior to sending signal anywhere, preamp gain or trim should be set correctly for the input source. Follow the [How to Use Gain Assistant section](#) for best results.

This ensures optimum signal level coming into the channel for processing, but more importantly when thinking about sending (routing) signals, changing the preamp gain or trim also affects the level of signal being sent to any outputs.

- i** Sends from Inputs to each Out can be set 'Pre or Post Fader' in the CONFIG / OUTPUTS screen. Post Fader means the channel send level to the output depends on both the set send level to the output and the send level to Main LR. Pre Fader sends on the other hand, are completely independent and mostly used for monitoring.
- i** Sends to Outputs 1-6 are sourced Post-PEQ (Pre-Comp) from input channels. This means that the full dynamic range is heard by performers in monitors, and that the compressor on each input affects only the Main LR.

Send one input at a time using the PROCESSING screen



1. Go to **PROCESSING / INPUTS** and select the channel to be sent.

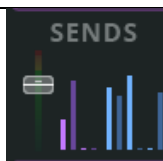

2. Touch/Click the SENDS section at the bottom of the channel strip to display and adjust all send levels for that channel.

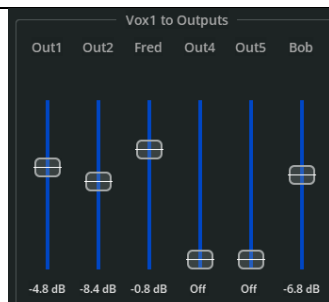

3. Use the blue faders to adjust the send levels from

Repeat steps 1 and 2 for other inputs as required.

Send multiple inputs to one Output using the FADER screen

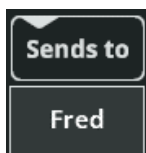

1. Go to the **FADER** screen and use the **Sends to** button, above the fader on the right-hand side, to select an output to send signal to.

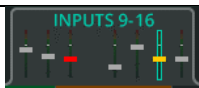

2. Use the tabs at the top of the screen to navigate between banks of Inputs.



3. Raise the fader for any Input in order to send signal from that input channel to the selected Output.

Touch/Click and drag faders, or select the fader and use the Touchscreen rotary control (CQ-12T, CQ-18T).



4. Adjust the (overall) Output level using the fader on the right-hand side.

-  Repeat steps 2 to 4 for different inputs and different outputs to set the mix for each.

Use the Feedback Assistant

The Feedback Assistant (**FBA**) detects the prominent and persistent frequencies caused by feedback, and then adds narrow filters to the output to reduce the levels of those frequencies whilst changing the overall sound as little as possible.

It can be used in any situation where the input source can 'hear' an output it is being sent to. Most commonly, a microphone being used in the same space as monitor speakers and PA system.

The **FBA** is designed to be used during setup and then to look out for feedback during the show or event. For best results always run through the setup steps whenever the setup or venue is changed.

False Positives and best practices

False positives can occur with any feedback-like sound being played (e.g. guitar feedback, keyboard and synth sounds, flute, operatic vocals etc...). The **FBA** cannot know if this is a desired feedback-like sound or not. The **FBA** on all channels will always boot with **HOLD** active to prevent unnecessary filters being added for this reason. It is best not to leave any **FBA** actively detecting and adding fixed filters. Instead, if being left unattended, it is best to leave the filter **Mode** as **Live**.

Detect and add Fixed filters to an Output during setup/soundcheck

This is the most important stage to prevent feedback during a show or event. Feedback can also be detected more accurately and quickly during setup/soundcheck and there is less chance of false positives.

Some Feedback must occur for the **FBA** to detect and filter it. Therefore, before doing anything, ensure that:

- All microphones to be used are connected and have preamp gain set.
- All Input processing has been set to an approximate starting point.
- All outputs have been connected and any speakers powered on.
- A rough mix should be set for monitors and other outputs (though with the output level lower than needed if feedback is already an issue).



1. Go to **CONFIG / OUTPUTS** and select the Output socket where Feedback Assistant (**FBA**) is needed. Settings will appear in the bottom half of the screen.

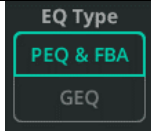

2. Set **EQ Type** to **PEQ & FBA** if it is not already.



3. Go to **PROCESSING / OUTPUTS**.

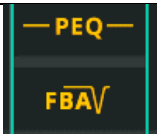

4. Select the Output channel, then select the channel's **FBA** to show details and controls.



5. At the bottom left of the screen, select the **DETECT** tab (if not already selected)

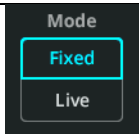

6. Set the filter **Mode** to **Fixed**. This will mean any detected feedback frequencies will have a fixed filter applied (which will remain until manually deleted).

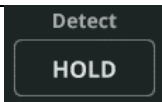

7. Disable **HOLD** to start detecting feedback frequencies; Enable **HOLD** to pause detection at any time



8. Enable the **RTA** (Real Time Analyser) to show the frequency content of the selected Output on the graph.

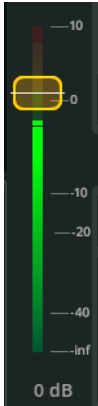

9. Gently raise the Output level fader to the right of the graph and controls.

As the output level increases, feedback will occur and the FBA will be able to detect it and add fixed filters.

Raise the fader to a higher level that it will be used at during the show or event to generate and detect as much potential feedback as possible and allow for changes to the mix (e.g. extra vocal being added later).

When all frequencies have been detected or all 12 Fixed filters have been used, lower the level again.

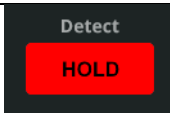

10. With setup detection complete, either engage **HOLD** or switch filter **Mode** to **Live**.

 Repeat for any other outputs as required.

Detect and add Live filters to an Output during a show or event

1. Follow the previous How To guide to add Fixed filters during setup whenever possible. This gives the best starting point for the **FBA**.



2. Go to **CONFIG / OUTPUTS** and select the Output socket where Feedback Assistant (**FBA**) is needed. Settings will appear in the bottom half of the screen.

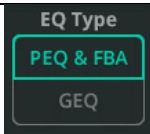

3. Set **EQ Type** to **PEQ & FBA** if it is not already.



4. Go to **PROCESSING / OUTPUTS**.

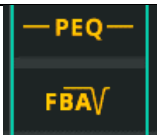

5. Select the Output channel, then select the channel's **FBA** to show details and controls.



6. At the bottom left of the screen, select the **DETECT** tab (if not already selected)

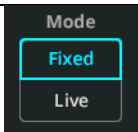

7. Set the filter **Mode** to **Live**. This will mean any detected feedback frequencies will have a live filter applied, which will immediately begin to recover.

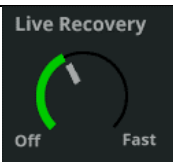

8. Set the rate of recovery for all **Live** filters. This can be adjusted at any time to speed up or slow down (or even pause) recovery. It does not affect fixed filters.



9. Disable **HOLD** to start detecting feedback frequencies; Enable **HOLD** to pause detection at any time



10. Enable the **RTA** (Real Time Analyser) to show the frequency content of the selected Output on the graph.

 Repeat for any other outputs as required.

Add and use FX

There are two ways to use each FX Unit, **Shared** or **Inserted**.

When in **Shared** Mode, the FX Unit processes signal from multiple channels at the same time. The 'wet' processed signal can then be sent, at different levels, to outputs and be heard alongside the 'dry' signals coming directly from the channels.

When **Inserted**, the FX Unit is used on a single input or output channel. Getting its signal from after the gate of an input channel or right at the beginning of an output channel. The FX Unit output is then fed back into the channel at the same point so all other processing (e.g. PEQ) will affect it.

Using an FX Unit in Shared Mode



1. Go to the **FX** screen and select one of the FX Units on the left-hand side.



2. To choose a different FX type, use the **Library** button at the right top corner of the screen, select an FX type or stored preset then recall it.



3. At the top of the screen, ensure the **CONTROL** tab is selected and the FX Unit controls are shown.

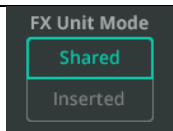

4. Toward the bottom left, set FX Unit Mode to **Shared** (if not already set).

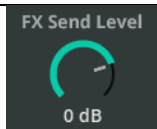

5. Set the **FX Send Level** to 0dB as a starting point. This can be adjusted at any time to control the overall signal level being fed into the FX Unit.

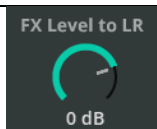

6. Set the **FX Level to LR** to 0dB as a starting point. This controls the amount of 'wet' FX signal being heard in the Main LR.



7. Switch to the **SENDS TO** tab at the top to display all channel sends to the selected FX Unit.

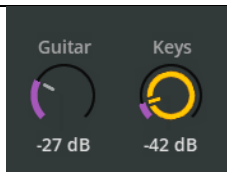

8. Select and adjust individual send levels to the FX Unit from each channel. Note that these send levels are the same as can be viewed on each channel from the **PROCESSING / SENDS** screen. They can also be adjusted using faders from the **FADER** screen by using **Sends to** and selecting an FX Unit.



9. Switch back to the **CONTROL** tab.



10. Adjust FX parameters. (Refer to the [FX section](#) of this guide for a detailed description and configuration of each FX).

Also set Mute Mode:

Trails On – Delays and reverbs decay naturally after muting.

Trails Off – Delays and reverbs stop immediately when muted.

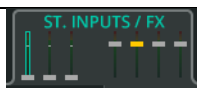

11. In the **PROCESSING** screen, select the **ST. INPUTS / FX tab**

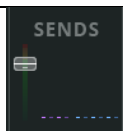

12. Select the FX Unit channel, then touch/click **SENDS** to show all send levels from that FX Unit.

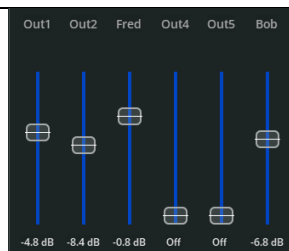

13. Adjust send levels to Main LR, other FX Units and Outputs 1-6 as required, so the FX is heard only where it should be.

Using an FX Unit in Inserted Mode



1. Go to the **FX** screen and select one of the FX Units on the left-hand side.



2. To choose a different FX type, use the **Library** button at the right top corner of the screen, select an FX type or stored preset then recall it.



3. At the top of the screen, ensure the **CONTROL** tab is selected and the FX Unit controls are shown.



4. Toward the bottom left, set FX Unit Mode to **Inserted** (if not already set) and select a channel to insert the FX Unit into from the pop-up.

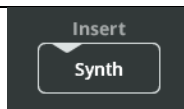

5. To change the channel the FX Unit is inserted into at any time, touch/click the **Insert (channel)** button.



6. Adjust FX parameters. (Refer to the [FX section](#) of this guide for a detailed description and configuration of each FX).

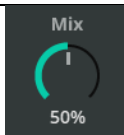

7. Use the **Mix** control to adjust the balance of signal between **0%** (only direct/'dry' signal, no FX heard) and **100%** (only FX/'wet' signal, no direct/'dry' signal heard).



8. Switch the inserted FX Unit in and out of the channel instantly using the **In/Out** button.

 Inserted FX Units are shown with an icon in the channel strip on the PROCESSING screen. Selecting this will jump to the FX Unit in the FX screen.

Send Audio to and from a DAW

CQ can send and receive multichannel audio with a built-in audio interface that connects to a computer or device via USB-B. The maximum number of channels that can be sent and received are:

CQ-12T: 16×16 (48/96kHz)

CQ-18T: 24×22 (48/96kHz)

CQ-20B: 24×24 (48/96kHz)

For capture and playback of an event, or for virtual soundcheck, signal is generally only sent *or* received at any time. In a studio environment however, sending *and* receiving signal at the same time is often required. This guide describes sending and receiving separately. For bidirectional use, simply ensure that audio is being sent from the DAW to the CQ using different channels than those being used to send audio from the CQ to the DAW.

- i** CQ mixers are Core Audio compliant so no driver is required; for lower latency connection with Windows systems, download and install the required ASIO driver from the A&H website: <https://www.allen-heath.com/cq>.

Send Audio from the CQ to a DAW:



1. Connect the CQ to the computer or device using a standard USB-B cable.



2. Go to **CONFIG / Digital Audio (Symbols) / USB/SD** to set up the connection.

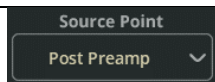

3. Select a point in the signal path of an Input channel to record from using **Source Point**

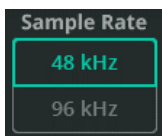

4. Select the **Sample Rate**. This should match the Sample Rate of the DAW session.

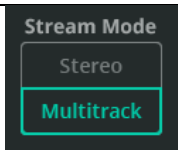

5. Select **Multitrack** for **Stream Mode** to send and receive all channels individually.

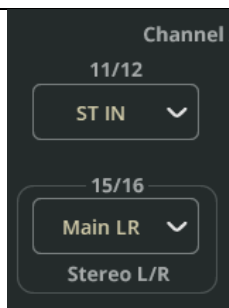

6. Assign outputs to the final pairs of channels as required. These can be stereo inputs, FX or outputs.

All mono (or stereo linked) channels are always patched to their matching channel number. e.g. CQ input 7 is being sent to USB channel 7.

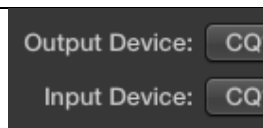

6. In the DAW audio preferences, select the CQ as the *Audio Input Device* or equivalent.



7. Assign the Input source of each track in the DAW to correspond to channels being sent from the CQ.

8. Done! Signal will now be available for recording and processing on each of the DAW tracks.

Send Audio from a DAW to the CQ:



1. Connect the CQ to the computer or device using a standard USB-B cable.



2. Go to **CONFIG / Digital Audio** (Symbols) / **USB/SD** to set up the connection.

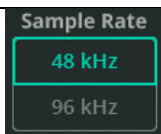

4. Select the **Sample Rate**. This should match the Sample Rate of the DAW session.

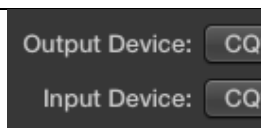

6. In the DAW audio preferences, select the CQ as the *Audio Output Device* or equivalent.

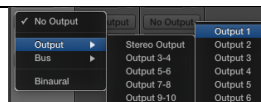

5. Assign the Output for each track in the DAW. Output channel numbers from the DAW match input channel numbers of the CQ.



6. On the CQ, go to **CONFIG / INPUTS** and select the required channels according to your DAW output assignments; Use Multi Select to select multiple inputs at the same time.

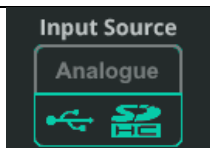

7. Switch **Input Source** to **USB/SD** (Symbols).

8. Done! Signal will now be sent to the CQ from the DAW and can be routed and processed as required.

Record/Playback Multitrack using an SD Card

For best results use **UHS-I, Class 10** SD card storage.



Other cards will work, though the maximum number of tracks that can be recorded may reduce, or more errors may occur. The maximum recording time is based on the FAT32 file system used, which allows for mono WAV recordings (one for each track) of around 8hrs (@48kHz) or 4hrs (@96kHz).

- i** Before using a card for recording, ensure it has been formatted in the CQ using the **HOME / SYSTEM / USB/SD** (Symbols) screen.
- i** More details on SD multitrack recording can be found in the **HOME / RECORD / Multitrack** section of this guide.

To record Multitrack on an SD Card



1. Go to **CONFIG / USB/SD/BLUETOOTH / USB/SD** to check and adjust settings.

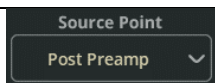

2. Select a point in the signal path of an Input channel to record from using **Source Point**

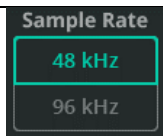

3. Select the **Sample Rate**. 48kHz allows for longer recording time and more channels to be recorded at a lower quality. 96kHz allows a maximum of 16 channels to be recorded for a shorter time but at the highest quality.

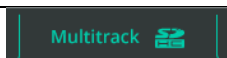

4. Go to **HOME / RECORD / MULTITRACK**

To record Multitrack on an SD Card



1. Go to **CONFIG / USB/SD/BLUETOOTH / USB/SD** to check and adjust settings.

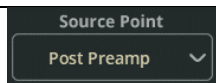

2. Select a point in the signal path of an Input channel to record from using **Source Point**

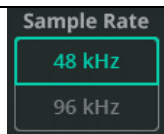

3. Select the **Sample Rate**. 48kHz allows for longer recording time and more channels to be recorded at a lower quality. 96kHz allows a maximum of 16 channels to be recorded for a shorter time but at the highest quality.

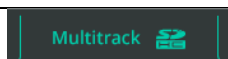

4. Go to **HOME / RECORD / MULTITRACK**

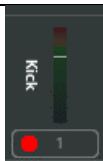

5. Arm each channel to be recorded using the **Arm** button below each channel meter. Armed channels are indicated with a red record symbol.



6. Ensure channels that are not be recorded show a grey record symbol, showing they are unarmed.



7. Use the **Recording** button in the transport bar to start recording to the SD card. A new folder will be created with empty files then recording will begin automatically.



8. Press the **Stop** button to finish the recording. When each recording is stopped, allow time for the recording to be finalised and the files stored correctly.

To Playback Multitrack from an SD Card



1. Go to **CONFIG / Digital Audio** (Symbols) / **USB/SD** to set up the connection.

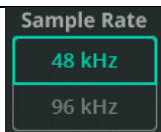

2. Select the **Sample Rate**. This should match the Sample Rate of recording.



3. On the CQ, go to **CONFIG / INPUTS** and select the channels to use for playback. Use Multi Select to select multiple inputs at the same time. Recorded audio will play back to the channel it was recorded from.

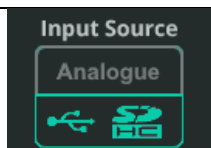

4. Switch **Input Source** to **USB/SD** (Symbols).

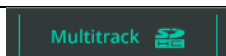

5. Go to **HOME / RECORD / Multitrack**

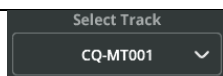

6. To select a stored multitrack file from the SD Card, touch the **Select Track** drop-down menu at the left bottom corner of the screen.

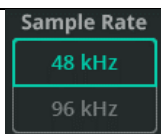

7. If a recording cannot be seen, try a different sample rate (steps 1 and 2).

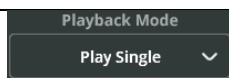

8. Use **Playback Mode** to select whether some, all or none of the recordings will be repeated.



9. Use the Transport bar to control playback.

Store and Recall settings

The CQ has 1 Show on it at any time. Up to 100 Scenes can be stored within each Show along with up to 128 Library items. Using these three separate data types, it's possible to store and recall anything from the settings of a PEQ on a single channel, to the entire setup of the CQ.

For more information on different types of storage in CQ, see the [Shows, Scenes and Libraries](#) section.

Store a Scene

A dark grey button with the word "SCENES" in teal capital letters.

1. Go to **HOME / SCENES**.

A dark grey button with a yellow border, containing the text "Store New" and a yellow floppy disk icon.

2. Select an available scene slot and use the **Store New** button to store the current state of the mixer as a Scene.

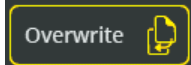
A dark grey button with a yellow border, containing the text "Overwrite" and a yellow floppy disk icon with a diagonal slash.

3. Alternatively, select an existing Scene and use **Overwrite** to store the current state of the mixer in place of the selected Scene.

A dark grey button with a yellow border, containing the text "Rename" and a yellow pencil icon.

4. Use **Rename** to change the name of the selected Scene.

Recall a Scene

A dark grey button with the word "SCENES" in teal capital letters.

1. Go to **HOME / SCENES**.

A dark grey button with a green border, containing the text "Recall" and a green right-pointing arrow.

2. Select a Scene from the list and use the **Recall** button to replace the current state of the CQ (all processing, FX Units and send levels) with the stored version.

 Note that any current settings will be overwritten and this can't be undone, so it is best practice to **Store** any changes *before* Recalling a Scene.

Store Processing Parameters Using Libraries

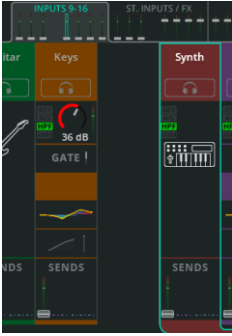

1. Go to **PROCESSING**, locate the bank of faders from the top of the screen containing the channel with processing to be stored.
2. Select the channel, then stay in bank view to store a whole channel or select a processing block (e.g. PEQ) to view in detail and store only that part of the processing.



3. Open the **Library** from the top right-hand corner of the screen. A different library will open depending on the screen currently being viewed.

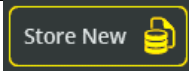

4. Select **Store new** to store all settings from the selected channel/processing block.

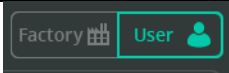

5. Switch to the **User** library to manage User Libraries.

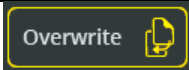

6. Select an existing item in the list and use **Overwrite** to store settings for the selected channel/processing block over the top of an existing item.

Recall Processing Parameters Using Libraries

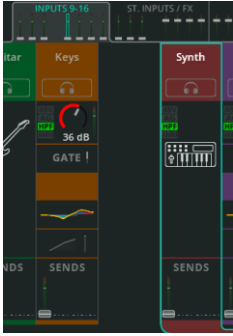

1. Go to **PROCESSING**, locate the bank of faders from the top of the screen containing the channel where the processing will be recalled to.
2. Select the channel, then stay in bank view to recall processing for a whole channel or select a processing block (e.g. Compressor) to view it in detail and recall only that part of the processing.



3. Open the **Library** from the top right-hand corner of the screen. A different library will open depending on the screen currently being viewed.

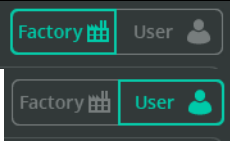

Switch between **Factory** and **User** Libraries to choose whether to view Library items in the mixer (Factory) or those stored by the User in the currently loaded Show.

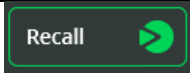

6. Select an item from the list then use **Recall** to replace the current settings of the channel or processing block with the stored settings.

i Whole channel libraries can also be accessed from the **CONFIG / INPUTS** and **CONFIG / OUTPUTS** screens. From here a recall will also include settings from the config screen e.g. name and preamp gain.

Store/Recall show files

- i** Show files can only be stored and recalled from/to a connected USB-A storage device which has been formatted correctly using the **HOME / SYSTEM / USB/SD** (Symbols) screen.



1. Connect a USB Drive to the USB-A port of the unit.

Shows

2. Go to **HOME / DATA / SHOWS**.

Store New 

3. Use **Store New** to store the current state of the CQ along with all Scenes and Libraries to the inserted USB drive as a new Show.

Overwrite 

6. Select an existing Show and use **Overwrite** to replace the contents of the selected Show on the drive with the current state of the CQ along with all Scenes and Libraries.

Rename 

4. Select **Rename** to change the name of the selected show file on the drive.

Delete 

5. Select **Delete** to remove the selected show file from the USB drive.

Recall 

8. Select a Show on the drive and use **Recall** to load all settings of the selected Show into the CQ.

- i** Note that any current settings will be overwritten and this cannot be undone, so it is best practice to **Store** all current settings to a Show as a backup *before* Recalling another one.

8. CONFIG

INPUTS

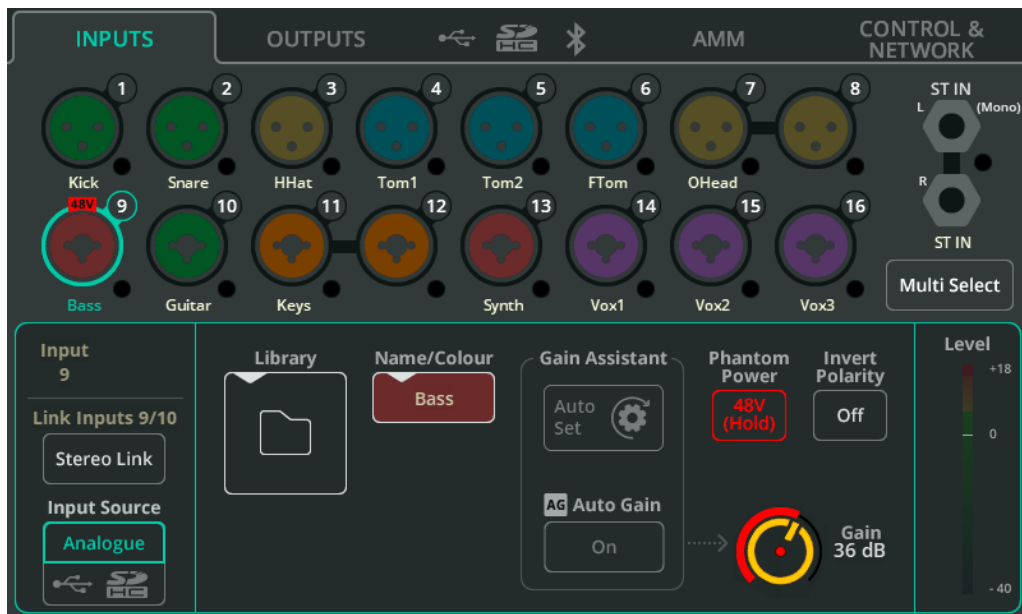

Input sockets are shown at the top of the screen, matching the hardware layout. Each includes a Chromatic Meter to show input signal.

Touch a socket to select it and display settings for that input/channel at the bottom.

Multi Select – Allows multiple inputs to be selected at once. This allows multiple input sources to be switched between analogue and digital in one go, or for Gain Assistant functions to be carried out on multiple analogue inputs at the same time.

Stereo Link – Use odd/even pairs of inputs as a single stereo channel (odd=left, even=right). When active, all settings, processing and routing applies to both and only one channel appears in the PROCESSING and FADER screens.

Input Source – Select Analogue to source the channel from the analogue sockets or select USB/SD to source from USB drive and SD card.

ⓘ When playing back from SD the source will be SD, otherwise it will be USB-B.

Library – Opens the channel library to store or recall all channel settings, including Name, Colour, Preamp and Processing. Quick and Complete libraries are available.

Name/Colour – Change the name and colour for the selected channel.

Gain Assistant – Touch Auto Set and generate noise in the microphone or with the connected instrument/device to automatically set preamp gain based on the level of signal received at the input. Switch on Auto Gain to automatically reduce the preamp gain and avoid clipping if high levels are detected.

Phantom Power – Touch and hold to activate +48V on the XLR input (Required for condenser microphones and active DI boxes).

 Phantom Power is only provided via an XLR connection. It is not sent to the ¼" TRS Jack connection of a Combi socket.

Invert Polarity – Invert the polarity of the signal. Often used where multiple microphones are used on the same source (e.g. snare top and snare bottom)

Gain – Adjust the gain manually for the incoming signal.

Trim – Digital level adjustment, available on stereo line inputs and when an input source is set to digital (USB/SD).

 Gain Assistant, Gain and Phantom Power are only available on Analogue Input Sources.

Level – Displays the post-preamp (pre-processing) input level.

OUTPUTS

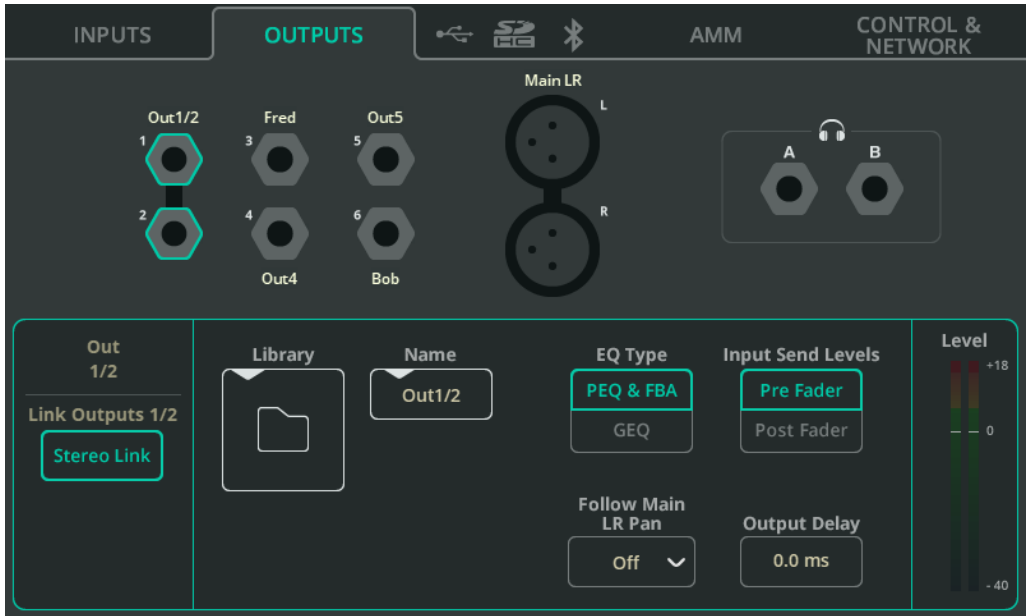

Output sockets are shown at the top of the screen, matching the hardware layout.

Touch a socket to select it and display settings for that output/channel at the bottom.

Stereo Link (Out 1-6 only) – Use odd/even pairs of outputs as a single stereo channel (odd=left, even=right). When active, all settings and processing apply to both.

Library – Opens the channel library to store or recall all channel settings, including Name.

EQ Type – Select either Parametric EQ plus Feedback Assistant or a Graphic EQ for each output.

Input Send Levels (Out 1-6 only) – Select whether send levels from the inputs are Pre Fader (independent of send levels to the Main LR output) or Post Fader (they ‘follow’ and are relative to the send levels of inputs to the Main LR output).

Follow Main LR Pan (Out 1-6 only) – Available on Outputs which are linked/stereo. Select whether panning of the inputs to the output are independent to the panning of inputs to the Main LR output (Off), or whether they follow them in the same direction (On) or the opposite direction (On – Inv)

- ❗ The On -Inv setting is useful for stereo on-stage monitoring, being that the left/right from the stage is the inverse of the left/right from the audience.

Output Delay – Delay each output by up to 682ms. Often used to time align fill speakers or for synchronising audio to video.

Headphone Output

Source – Select Listen to have the headphone output work with the Listen buttons (with headphone symbol) on each channel. Set to a mono or stereo mix to use as a monitor output with independent send levels to the Main LR.

- ❗ If Listen is set, when no Listen button is pressed, the headphone output will be sourced from Main LR.

Volume – Set the headphone output level.

- ❗ Headphone level can also be controlled from the home screen. To access quickly on the CQ-12T or CQ-18T, press the HOME screen key once or twice to display and adjust.

The CQ-18T has two headphone outputs which can be set up individually. For example, it is possible to have one headphone output set to Listen and the other to be fed with one of the monitor mixes.

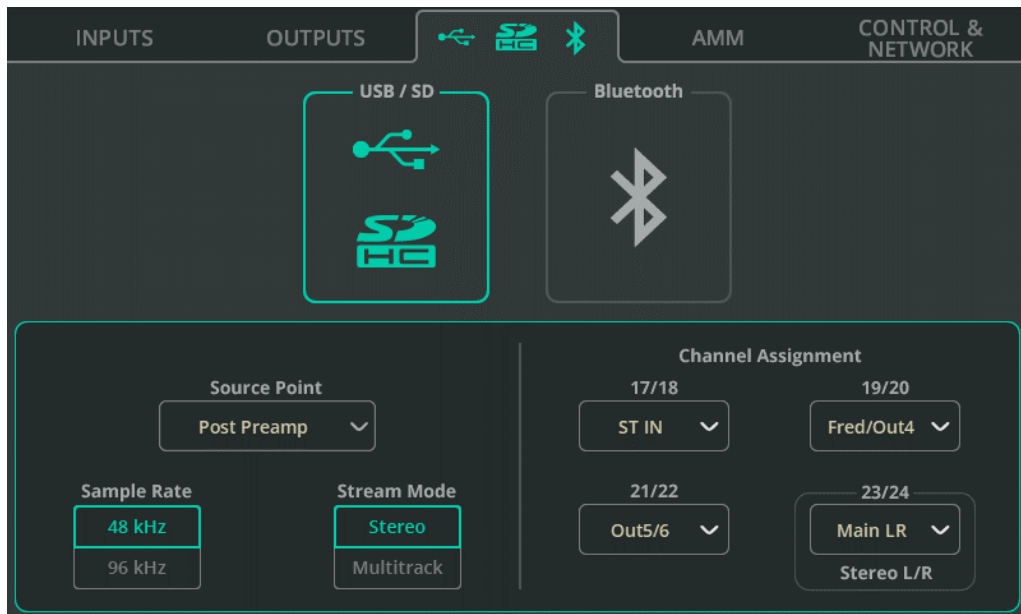

Source Point – Choose whether the signal being sent to USB/SD from input channels includes no input channel processing, some processing, or all processing.

Sample Rate – Select between 48kHz or 96kHz. This affects USB-A recording, the USB-B connection to a computer and SD recording. With SD recording on the CQ-18T and CQ-20B, up to 16 channels can be recorded or played back at 96kHz and all available channels can be recorded or played back at 48kHz.

i SD card playback of 48kHz multitracks is not possible when set to 96kHz and vice versa.

Stream Mode – Select between a Stereo or Multitrack output for the USB-B connection. When set to Stereo, the output signal is that set in the Channel Assignment labelled 'Stereo L/R'.

Set to Stereo for streaming or recording with mobile devices that do not support multichannel audio devices.

Set to Multitrack for multichannel recording to and from a DAW.

Channel Assignment – Mono input channels are permanently assigned to USB/SD outputs. In addition to these, the CQ-12T has 3 assignable stereo outputs and the CQ-18T and CQ-20B each have 4 assignable stereo outputs. These allow recording and playback of stereo line inputs, FX units, Main LR output or outputs 1-6.

The last stereo pair is set to Main LR by default and as well as being sent to multitrack outputs, is used for stereo recording to USB-A or when the USB-B Stream Mode is set to Stereo.

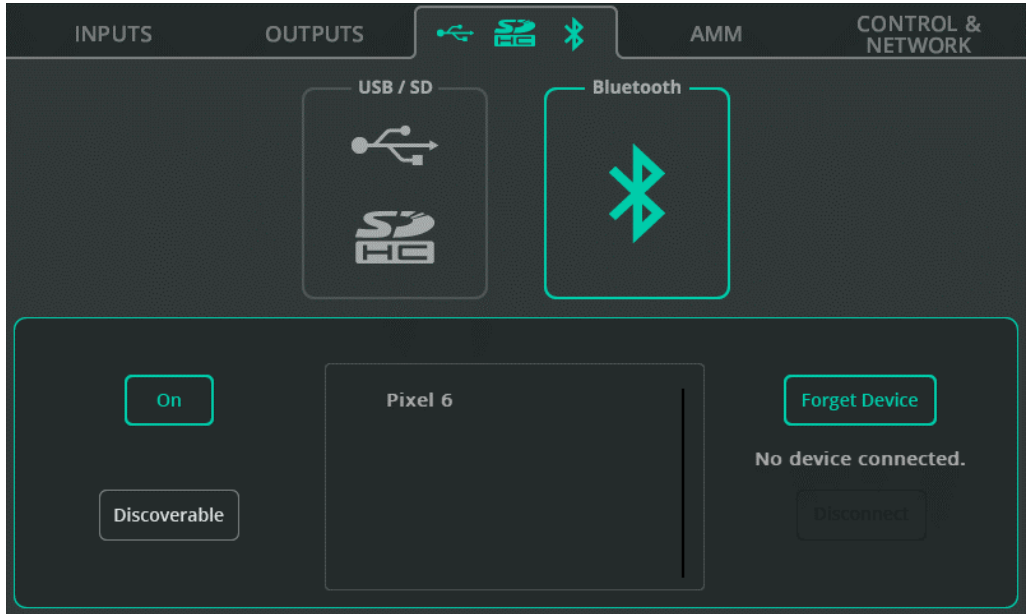

On/Off – Turn Bluetooth on or off.

Discoverable – Allow the CQ unit to be seen by other Bluetooth devices. Activate this then add the CQ as a Bluetooth device to a phone, tablet, or computer.

Forget Device – Select a previously connected device from the list, then use this to prevent it from connecting in future.

i Devices can always be connected again using the Discoverable button.

Disconnect – Terminate connection with the selected device.

i The CQ-12T requires that a PIN is used for connection. This is set as 1969 (the year Allen & Heath was founded).

AMM (Auto Mic Mixer)

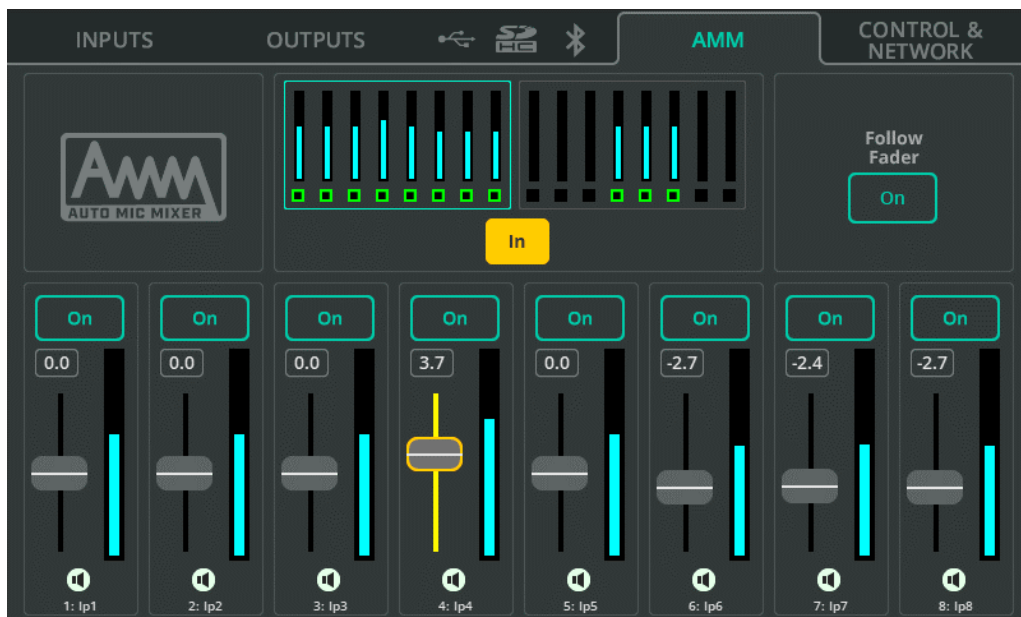

CQ's Automatic Microphone Mixer uses a gain sharing algorithm, designed for use in multi-microphone speech applications like conferences, meetings, broadcasting and podcasts. It can be used on every mono input channel of the CQ with two banks shown at the top of the page.

The AMM algorithm looks at the incoming signal level, the priority setting and (optionally) the fader level, then adds gain (level) to any channel in use, while reducing gain on the other channels. This reduces background noise and the chance of feedback while improving intelligibility.

In/Out – Switch the whole AMM on or off.

On/Off – Enable or disable AMM on each channel individually.

Priority Faders – Adjust priority of each channel in the calculation.

Follow Fader – When on, the calculation considers the input send level to Main LR.

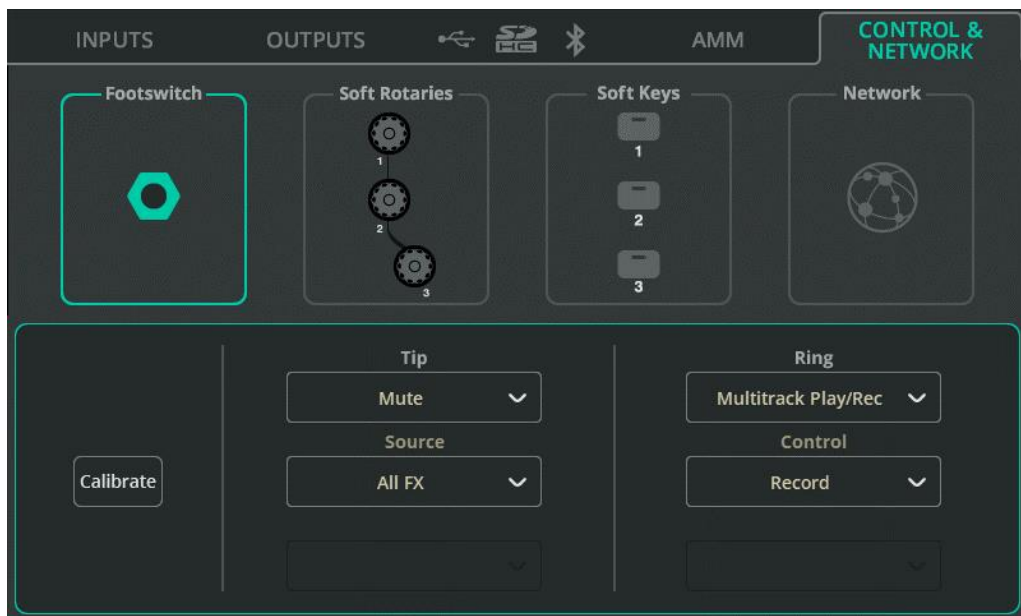

A single footswitch using a TS (Tip, Sleeve) connection or a dual footswitch using a TRS (Tip, Ring, Sleeve) connection can be used with CQ.

Each switch can be set for independently for Latching, Momentary or Soft Latch (momentary acting as latching) operation.

Calibrate – Follow steps to detect and set up a connected footswitch.

Tip/Ring – Assign the function to be performed by each footswitch. If using a single TS footswitch, assign only Tip.

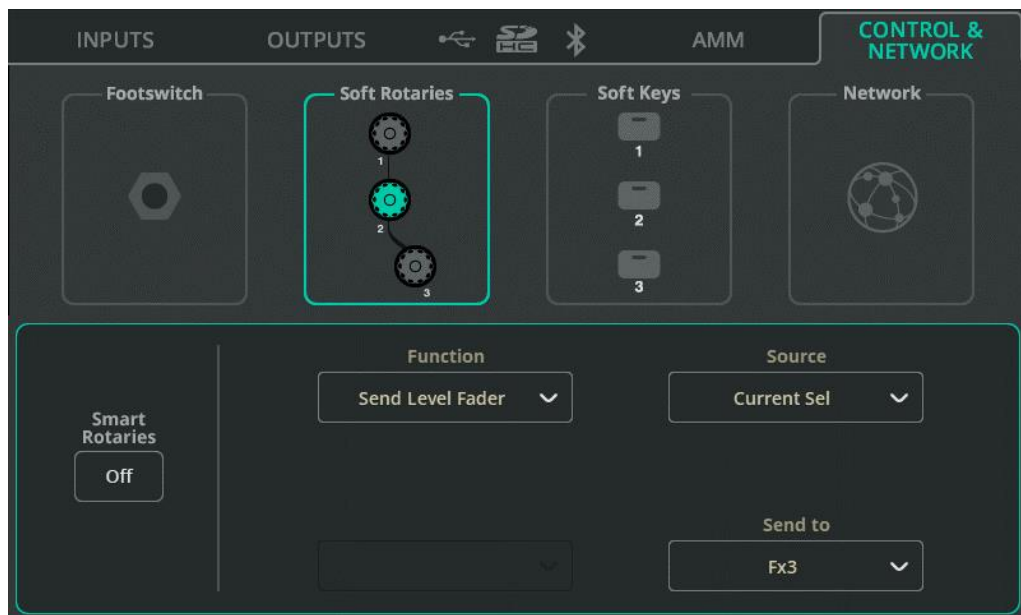

Each Soft Rotary can be selected individually.

Smart Rotaries – When turned on, rotaries are automatically mapped to controls depending on the screen being viewed. For example, in the input channel bank view, they will control Gain, Pan and Level, then when viewing a PEQ, they will control Width, Frequency and Gain of the last adjusted band.

This feature works globally for all three Soft Rotaries and will prevent assignment of other functions until disabled.

Function – Assign a function to the selected Soft Rotary.

Once the function is selected, further options will appear e.g. for channel selection.

- ❗ Use 'Current Sel' in the Source option to have the Soft Rotary control the selected function for the currently selected channel. In this way, it's possible to do things like quickly adjust send levels to a particular output or FX unit from the last selected channel and when viewing any other screen.

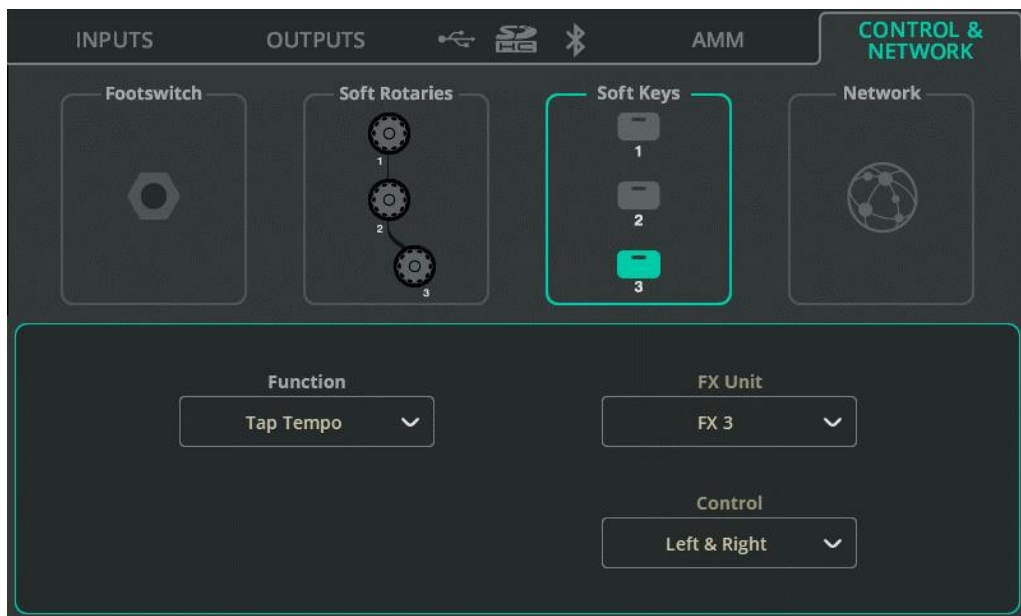

Each Soft Key can be selected individually.

Function - Assign a function to the selected Soft Key.

Once the function is selected, further options will appear e.g. for channel selection.

Options include:

- AMM and Processing In/Out controls, Listen, Mute and Centre Panning for specific channels or the currently selected channel
- Scene Controls
- Record/Playback Controls
- FX Delay Tap Tempo
- Smart Rotaries On/Off (CQ-18T)

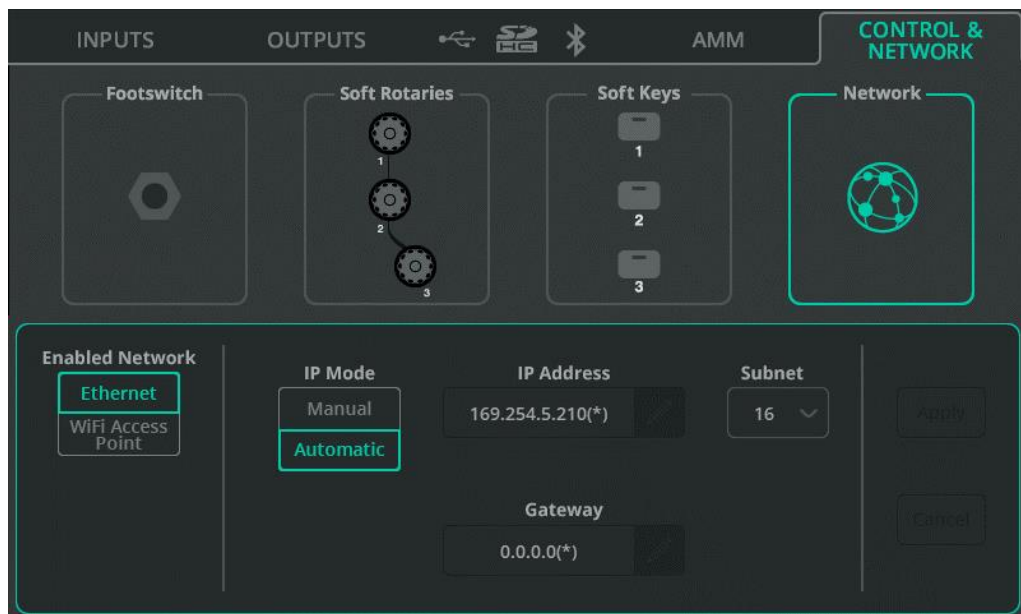

Enabled Network – Select **Ethernet** for wired connection through the Network port. Select **Wi-Fi Access Point** for wireless connection using the integrated access point of the unit (CQ-18T, CQ-20B).

IP Mode – It is recommended that IP Mode is left set to Automatic, to allow address assignment via DHCP when possible. Setting IP Mode to Manual should only be required where a DHCP host is not available, or for setups where an IT or networking team needs to allow access and wants the unit to always have the same address.

- ❗ When IP Mode is set to Automatic and no IP address is provided to the CQ, it will auto assign itself an address. This is noted by a (*) appearing after the address in the network config and system information screens.
- ❗ If IP Mode is set to Manual and the change is applied before editing the address, gateway and subnet, the defaults can be found in the [Default Network Settings](#) section of this guide.

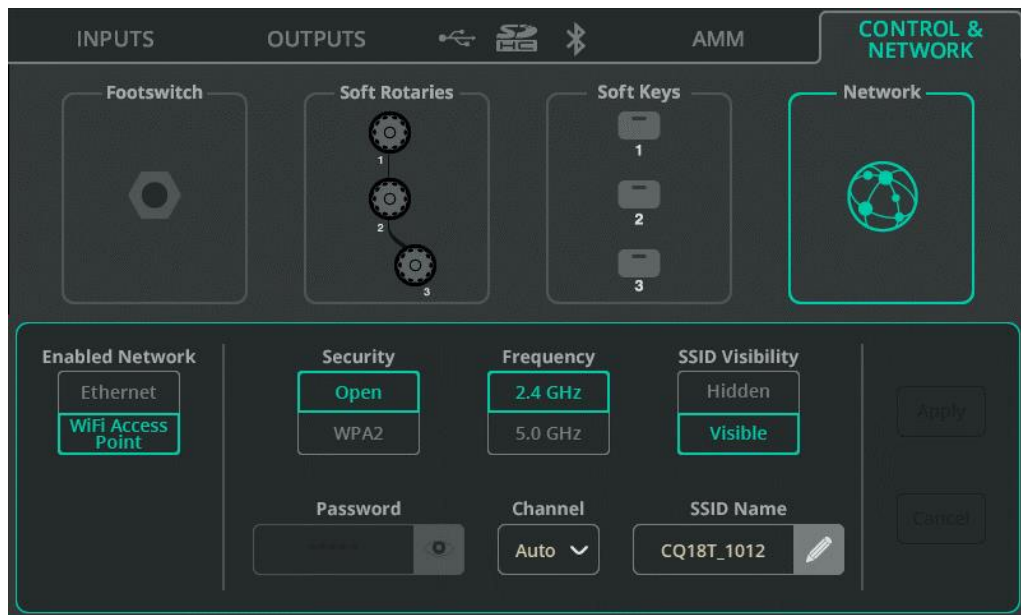

Enabled Network – Select **Ethernet** for wired connection through the Network port. Select **Wi-Fi Access Point** for wireless connection using the integrated access point of the unit (CQ-18T, CQ-20B).

Security – Select between an open access point or a WPA2 password protected network.

Password – When WPA2 is selected, set a password here. The default password is 'DefaultPassword'

Frequency – Choose between use of 2.4GHz or 5GHz frequency bands.

Channel – Select a channel (it is recommended to leave Auto set).

SSID Visibility – Choose whether the network name is broadcast openly.

SSID Name – Assign a custom name for the network. The default name is the CQ model followed by the last 4 digits of the serial number.

9. PROCESSING

INPUTS (bank view)

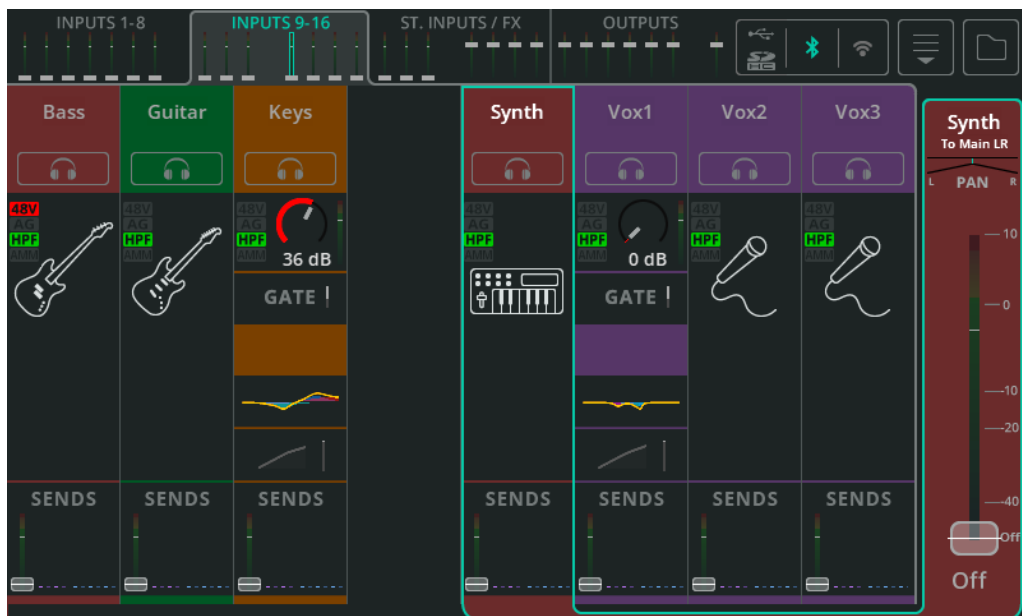

The bank view displays one of four banks at a time, each showing up to eight input, FX or output channels. Switch between banks using the tabs with mini faders and meters at the top (when using a CQ-12T or CQ-18T touchscreen) or bottom left (when using the CQ-MixPad app).

The tabs display the main fader for each channel. Either input channel sends to the Main LR, the Overall FX send level or overall Output levels. If a channel is muted, the fader cap is coloured red. If Listen is active on a channel, the fader cap is coloured yellow.

Also displayed at the top of the screen is indication of connected USB and SD storage, Bluetooth on/off, Wi-Fi on/off (CQ-18T, CQ-20B).

At the top right of the screen are the Copy, Paste, Reset, Quick Fire and Convert menu and the Library button.

Quick Channel and Complete Channel differences

A Quick Channel shows the Quick Channel icon for the Quick Channel being used.

A Complete Channel is shown as separate processing 'blocks' with signal path running from top to bottom, so for example, the signal will pass through the gate before going through the PEQ. Each of these blocks displays useful information such as whether the gate is open or whether compression is being applied. If a processing block is switched Out, it will show without colour.

Sends

At the bottom of each input channel is the SENDS section which shows the send level to the Main LR with the meter and fader (as in the bank tabs at the top). It also displays send levels to FX units and Outputs 1-6.

Navigation

Touch a channel to select it and show its main fader on the right-hand side.

 Selection of a channel is followed through CONFIG, PROCESSING and FADER screens.

Touch any processing or the sends block of a selected channel to view processing in detail and make adjustments.

When viewing processing in more detail, the channel processing blocks will move to the right, in place of the channel fader in bank view. It is then possible to navigate quickly by selecting different processing blocks on the right and selecting different channels at the top.

 Touching an FX unit which has been inserted on a channel will switch to the FX screen to make any adjustments.



CQ includes Quick Channels for a variety of common audio sources which provide a quick and easy way to adjust multiple channel processing parameters with a few controls. This enables the mix to be put together much faster than with conventional controls and if more control is required, Quick Channels can be converted to Complete Channels at any time.

To use a Quick Channel:

1. Recall from the Quick tab of the Channel library, either available from the **CONFIG / INPUTS** screen, or when in the **PROCESSING / INPUTS** bank view.
2. Select an instrument or style (where available) to get the perfect starting point.
3. Adjust controls.
4. Done!

Drums/Percussion Quick Channel Example



A 'one knob' Quick Channel has instrument or source types on the left-hand side.

Select one of the options on the left, then touch the large main dial and use the touchscreen rotary (CQ-12T, CQ-18T) or touch and drag (CQ-MixPad) to adjust to taste.

Switch Gate, Compressor or Limiter options In or Out using the buttons at the bottom.

- ❗ Use the Listen button above the Quick Channel icon on the right to listen to only this input in the headphones.

Bass Quick Channel Example



A 'three knob' Quick Channel has styles or types on a selection dial.

Select one of the options on the dial by selecting and turning it, or by touching directly on the desired option.

Use the three controls at the bottom right to make adjustments.

- ⓘ Note that when a style is selected and these controls are in their mid (12 o'clock) position, processing is not flat.

Switch processing options In or Out using buttons at the top.

- ⓘ Use the Listen button above the Quick Channel icon on the right to listen to only this input in the headphones.

EasyEQ Quick Channel Example



The EasyEQ is a unique Quick Channel which is in fact a model of the MusiQ found in the Allen & Heath ZED range of analogue mixers, with the added benefit of a compressor.

Low – Cut or boost Low frequencies.

Mid – Cut or boost Mid frequencies.

High – Cut or boost High frequencies.

HPF – Switch High Pass Filter In/Out

Comp – Switch Compression In/Out.

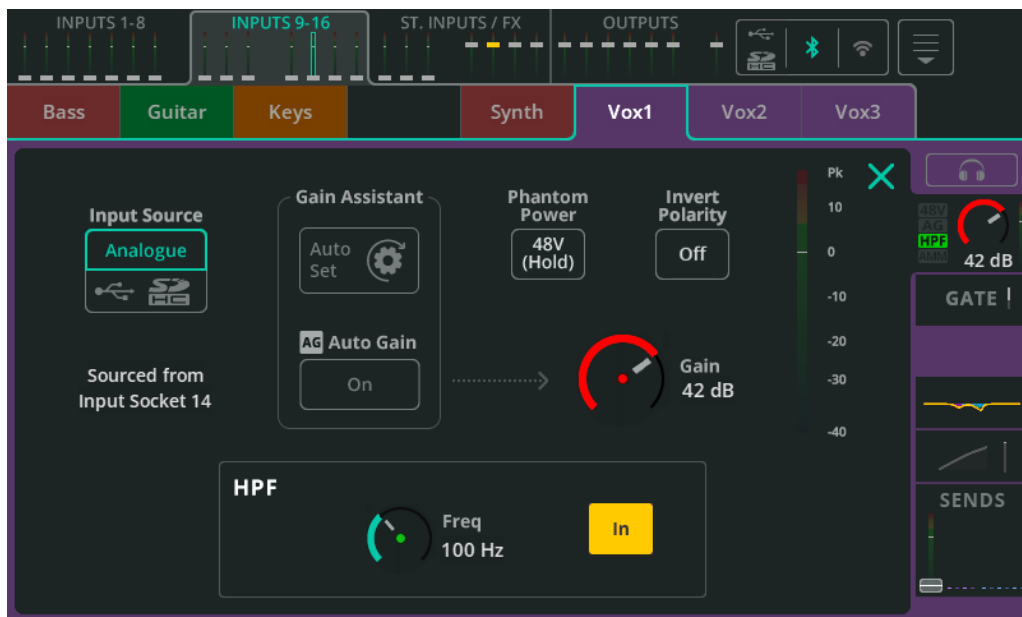

Input Source – Select Analogue to source the channel from the analogue sockets or select USB/SD to source from USB drive and SD card.

The current source for this input channel is displayed below.

i When playing back from SD the source will be SD, otherwise it will be USB-B.

Gain Assistant – Touch Auto Set and generate noise in the microphone or with the connected instrument/device to automatically set preamp gain based on the level of signal received at the input. Switch on Auto Gain to automatically reduce the preamp gain and avoid clipping if high levels are detected.

Phantom Power – Touch and hold to activate +48V on the XLR input (Required for condenser microphones and active DI boxes).

i Phantom Power is only provided via an XLR connection. It is not sent to the ¼" TRS Jack connection of a Combi socket.

Invert Polarity – Invert the polarity of the signal. Often used where multiple microphones are used on the same source (e.g. snare top and snare bottom)

Gain – Adjust the gain manually for the incoming signal.

Trim – Digital level adjustment, available on stereo line inputs and when an input source is set to digital (USB/SD).

 Gain Assistant, Gain and Phantom Power are only available on Analogue Input Sources.

Level – Displays the post-preamp (pre-processing) input level.

HPF

The High Pass Filter lets audio above a set frequency through whilst cutting out lower frequencies. It's commonly used wherever the low frequencies are undesirable (e.g. microphone handling noise, traffic rumble or low background humming) or when it is not adding anything to the mix (e.g. on predominantly mid or high frequency sources like voice, guitar or cymbals).

Freq – Adjust the High Pass Filter frequency. When HPF is In, all frequencies above this setting will pass whilst those below will be attenuated.

In/Out – Switch the HPF In or Out.



A Gate allows wanted signal through and attenuates unwanted signal. It has many uses including removal of hum from an idle instrument or avoiding hearing the snare drum through a tom microphone when only the snare is being played.

Attack – Adjust time it takes for the Gate to open once signal has reached threshold.

Hold – Adjust time the Gate remains open after signal has dropped below threshold.

Release – Adjust time it takes for the Gate to fully close once signal has fallen under the threshold and hold time has expired.

Threshold – Adjust the level at which the Gate is triggered to open.

Depth – Adjust the amount the signal is reduced by when the gate is fully closed.

In/Out – Enable or disable the Gate.



The 4-band Parametric Equaliser enables adjustments to the tone of the signal by cutting or boosting around different frequencies.

Type – LF and HF bands include options for Shelf, Bell or HPF/LPF.

Width – Adjust the amount that frequencies around the centre frequency are affected.

Frequency – Select the centre frequency for adjustment.

Gain – Cut or boost the selected centre frequency by up to +/- 15dB.

RTA – Display Real Time Analyser behind PEQ.

In/Out – Enable or disable the PEQ.



A Compressor is used to control and reduce the dynamic range of the signal.

RMS/Peak – Compression is either triggered by RMS (short average) or Peak (instant) signal level.

Hard/Soft Knee – With a hard knee, compression begins to take effect only when the threshold is reached. With a soft knee, the compression begins to take effect earlier but in a more gradual way.

Attack – Adjust the time it takes for compression to take effect once the signal has reached the threshold. Set a longer time to allow transients through and compress only the body of the sound, set a shorter time to flatten the signal and tame peaks.

Release – Adjust the time that it takes for the compressor to stop compressing after signal has fallen below the threshold.

Ratio – The ratio of the incoming signal to compressed signal when compression is active. E.g. when set to 3:1 and when compressing, every 3dB increase in level at the input will result in only a 1dB increase of level at the output.

Threshold – Adjust the input level at which compression will be active.

Gain – Use to compensate for the resulting attenuation of the signal.

In/Out – Enable or disable the compressor.



The SENDS section shows all send levels from an input or FX channel to all possible destinations.

Input to Main LR / Pan – Adjust the send level and stereo position of the selected channel to Main LR. This is also the fader shown in the bank tabs at the top of the PROCESSING and FADER screens, in bank view with the channel selected, and in the FADER screen when Sends to is set to Main LR.

Pan (Main LR) – Position the sound in the Main LR stereo image.

Input to FX – Adjust the send level from the channel to shared FX units.

- ⓘ Sends to shared FX are Post Fader and are affected by the Input to Main LR fader level.

Input to Outputs / Pan – Adjust the send level from the channel to Outputs.

- ⓘ Sends to Outputs can be set Pre Fader or Post Fader in the CONFIG / OUTPUTS screen.
- ⓘ Pan appears when Outputs have been stereo linked and can be adjusted when Follow Main LR Pan is set 'Off' in the CONFIG / OUTPUTS screen.

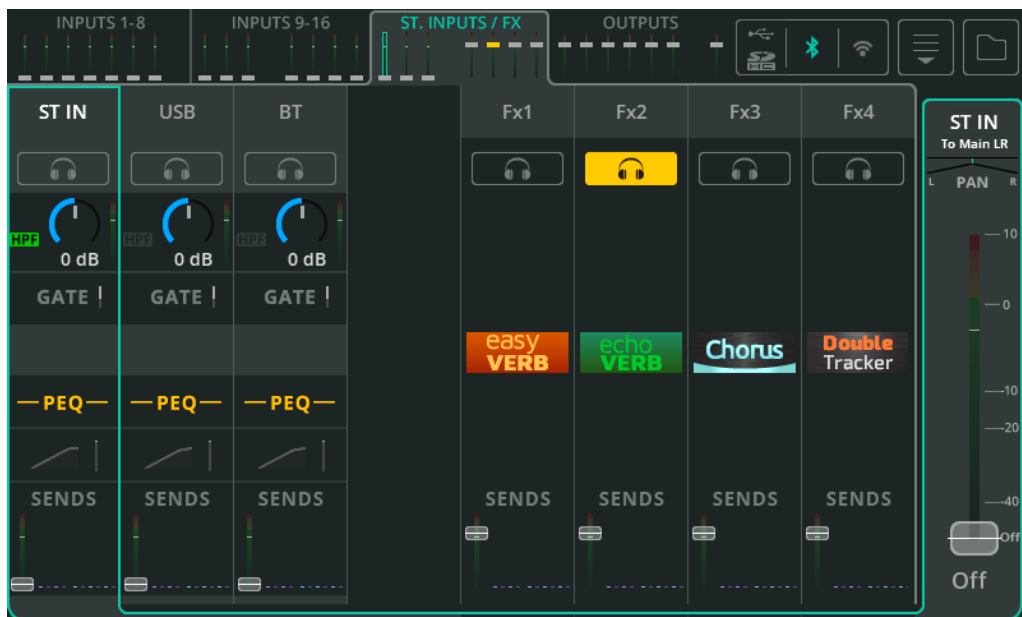

This bank includes three (CQ-12T, CQ-18T) or four (CQ-20B) stereo inputs. These are dedicated stereo channels for

- Stereo line level inputs
- Stereo USB channel, which can be used as a return from a DAW or for playback of stereo audio from USB storage
- The Bluetooth audio input

They work in the same way as all other input channels and have all the same processing options available.

Also in this bank are up to two (CQ-12T) or four (CQ-18T, CQ-20B) stereo FX channels.

Use the SENDS section on these channels to choose where the wet/affected signal from the FX unit is sent. For example, to hear reverb in a monitor, or cascade one FX unit into another.

OUTPUTS (bank view)

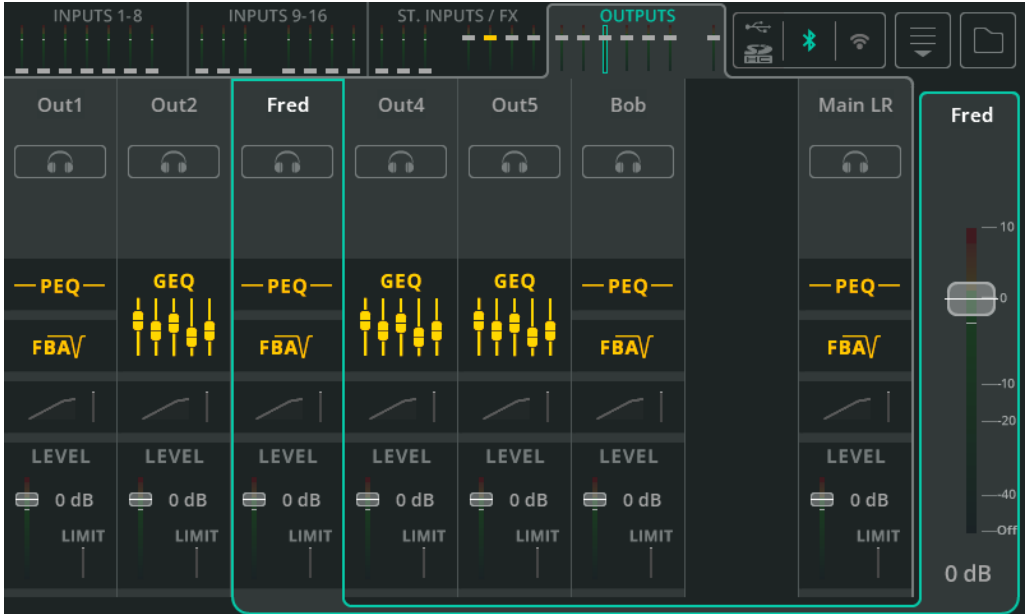

The Outputs bank includes the six Outputs and Main LR processing channels.

Output processing is slightly different to input processing and also depends on the EQ Type set per output in the **CONFIG / OUTPUTS** screen.

As with Input processing, signal flow runs from top to bottom and touching any output will select it and show its main fader (Output level) on the right-hand side.

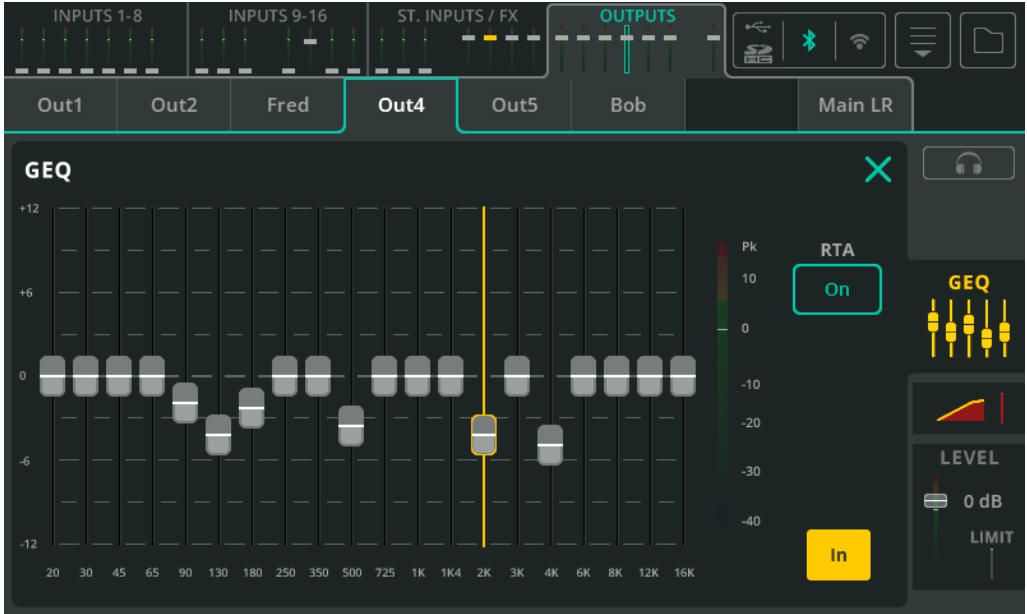

A GEQ is used to cut or boost specific frequencies in the signal.

Fader – Touch and drag or select a band and use the touchscreen rotary (CQ-12T, CQ-18T) to cut or boost by up to 12dB.

RTA – Enable this option to see a Real Time Analyser on the GEQ.

In/Out – Enable or disable the GEQ.

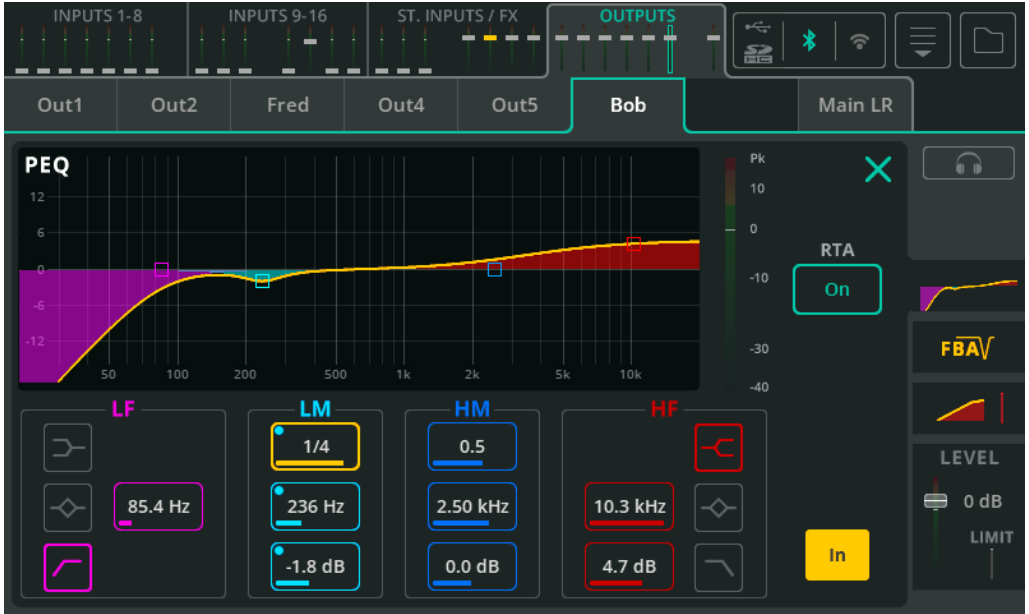

The 4-band Parametric Equaliser enables adjustments to the tone of the signal by cutting or boosting around different frequencies.

Type – LF and HF bands include options for Shelf, Bell or HPF/LPF.

Width – Adjust the amount that frequencies around the centre frequency are affected.

Frequency – Select the centre frequency for adjustment.

Gain – Cut or boost the selected centre frequency by up to +/- 15dB

RTA – Display Real Time Analyser behind PEQ.

In/Out – Enable or disable the PEQ.

Detect

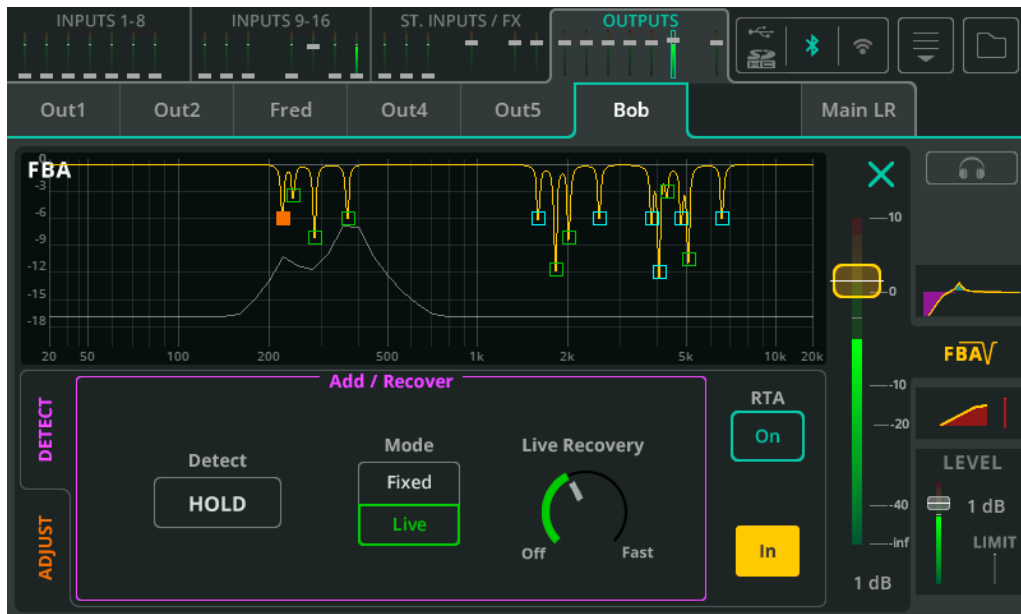

The Feedback Assistant detects feedback and applies narrow filters to prevent it.

Detect – Disable the 'HOLD' box to start detecting feedback frequencies; Enable the 'HOLD' box to pause feedback frequency detection.

Mode – Select whether the next filter to be added (when feedback is detected) will be in Fixed or Live mode.

Live Recovery – Adjust the speed at which Live filters are currently recovering. Can be set to 'Off' to temporarily freeze live filters.

RTA – Enable this option to see a Real Time Analyser in the FBA graph.

In/Out – Select to enable or disable the Feedback Assistant.

Adjust

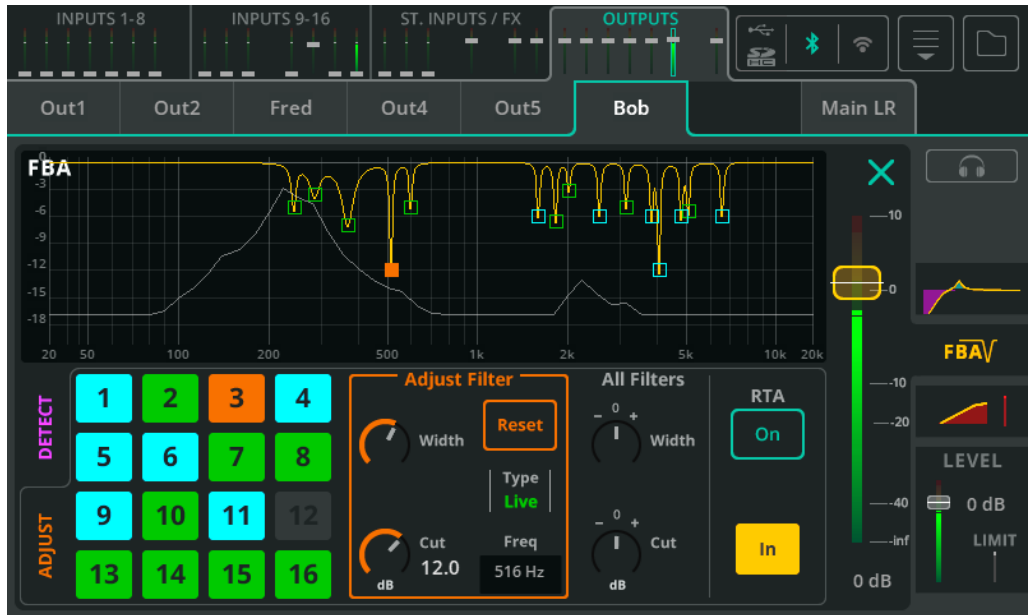

Each box on the left represents one of the 16 total filters.

Blue – Fixed mode filters.

Green – Live mode filters.

Orange – Currently selected filter.

Touch a box or a point on the graph to select a filter for adjustment.

Adjust Filter – Make width and cut adjustments to the selected filter. Select 'Reset' to remove the filter and make it available for use by the detector.

All Filters – Adjust width and cut for all active filters at once.

- ❗ To reset all filters, use the reset option from the dropdown menu at the top right of the screen.

Filter Modes

Fixed filters remain in place until they are manually deleted, the FBA is completely reset, or if the Feedback Assistant ‘steals’ them. Up to 12 of the 16 filters can be in Fixed mode, always leaving 4 for use in Live mode.

Live filters recover over time and once fully recovered, will switch back to being unused filters. They can be deleted individually or with a complete FBA reset. All of the 16 filters can be used in Live mode.

Automatic re-use of filters

When all filters are already in use, but a new feedback frequency is detected, the Feedback Assistant can re-use or ‘steal’ an existing filter, using logic to decide the best possible outcome i.e. the least amount of feedback.

Note that Live mode filters can only steal other filters already in live mode and Fixed mode filters can steal any filters.

On power up

Every time the CQ is booted, all Feedback Assistant instances are set to a ‘pre-show’ state. Fixed filters, the Live Recovery setting, ‘All Filters’ settings and In/Out state are remembered from last power down. Any Live filters will have been removed. Detect Hold is active. Mode is set to ‘Fixed’.

Copy/Paste

Copying and pasting includes all filters and settings (e.g. Live Recovery). This means that when pasting to another output (or back to the same output), the state of the FBA will be exactly the same.

Store/Recall

When using the FBA Library, Live filters are not stored or recalled. All Fixed filters, the Live Recovery setting, ‘All Filters’ settings and the In/Out state are stored and can be recalled.

Scene changes

Scene changes do not affect the Feedback Assistant settings directly, but they will usually change levels and processing which might affect which frequencies are more likely to feed back.



A Compressor is used to control and reduce the dynamic range of the signal.

RMS/Peak – Compression is either triggered by RMS (short average) or Peak (instant) signal level.

Hard/Soft Knee – With a hard knee, compression begins to take effect only when the threshold is reached. With a soft knee, the compression begins to take effect earlier but in a more gradual way.

Attack – Adjust the time it takes for compression to take effect once the signal has reached the threshold. Set a longer time to allow transients through and compress only the body of the sound, set a shorter time to flatten the signal and tame peaks.

Release – Adjust the time that it takes for the compressor to stop compressing after signal has fallen below the threshold.

Ratio – The ratio of the incoming signal to compressed signal when compression is active. E.g. when set to 3:1 and when compressing, every 3dB increase in level at the input will result in only a 1dB increase of level at the output.

Threshold – Adjust the input level at which compression will be active.

Gain – Use to compensate for the resulting attenuation of the signal.

In/Out – Enable or disable the compressor.



A Limiter works like a very fast compressor with an infinite:1 compression ratio and limits the output level to whatever is set by the threshold.

In CQ, the limiter is applied post fader, meaning that it can be set for use on an output for monitoring and prevent the output signal rising above a set level, even if the output level fader is adjusted by a musician using CQ4You for example.

Fast/Slow – Select the speed of the Limiter on the signal.

Threshold – Set the level when the limiter will be triggered (effectively maximum output level).

In/Out – Enable or disable the Limiter.

10. FADER

Sends to Main LR



The Fader screen displays up to eight channels at a time. Use the mini fader tabs at the top (touchscreen) or bottom left (CQ-MixPad) to switch between the 4 banks of channels. Use the **Faders Only** button at the top right to either show channel Listen, Pan and Mute controls, or longer faders with no controls.

Pan – Position the signal in the stereo image from left to right.

Level – Touch and drag (multiple) faders to adjust signal level or select a fader and use the Touchscreen rotary to adjust (CQ-12T, CQ-18T).

- ❗ Only FX units in shared mode can be 'Sent to' MainLR, an Output or another FX Unit.
- ❗ Outputs cannot be sent to other Outputs, so their fader always controls their output level.

Mute – Touch Mute to prevent flow of signal from the channel to any output or FX unit.

- ❗ Muted channels are indicated with a red fader cap on the mini faders at the top (touchscreen) or bottom left (CQ-MixPad).

Sends to an Output

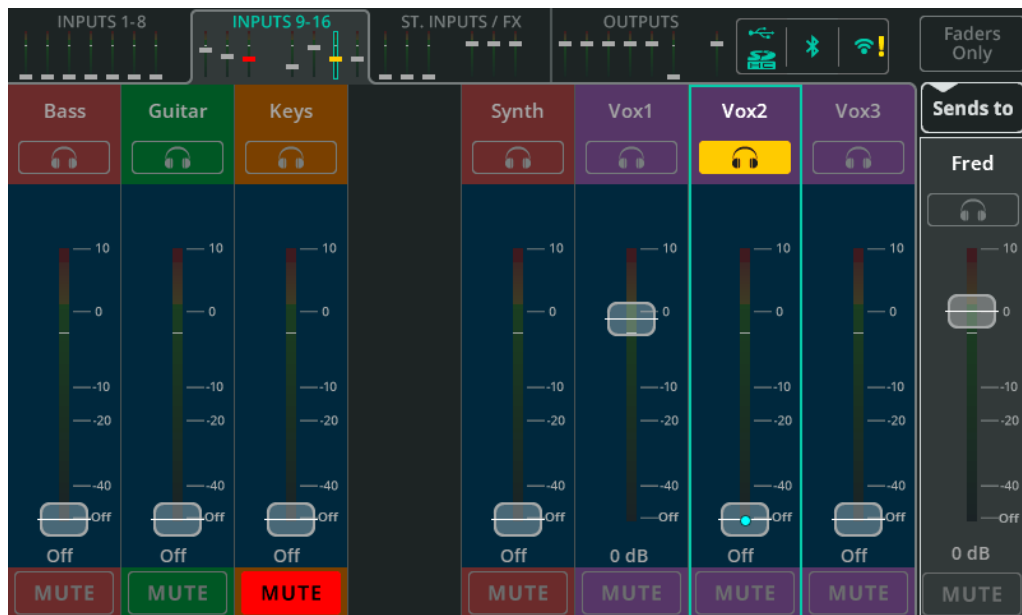

Touch **Sends to** and select an output to show all send levels to that output on the fader for each input and FX channel.

With an Output other than Main LR selected, the fader background is coloured blue to indicate that fader positions are showing the 'Sends to' an output other than Main LR.

- ❗ Only FX units in shared mode can be 'Sent to' MainLR, an Output or another FX Unit.
- ❗ Outputs cannot be sent to other Outputs, so their fader always controls their output level.

When sending to a stereo output, pan controls are available, though if **Follow Main LR Pan** is On for the selected output, the pan value is only displayed and cannot be adjusted.

The RHS fader is used to control the overall send, or output level. This is a duplicate of the output channel fader in the OUTPUTS bank view.

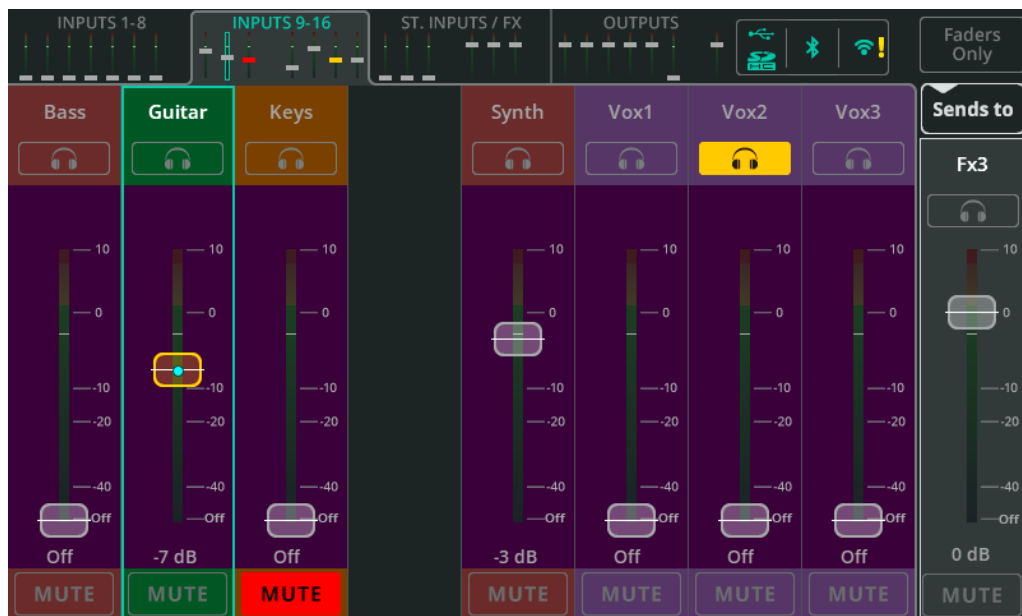

Touch **Sends to** and select an FX to show all send levels to that FX unit on the fader for each input and FX channel.

When Sends to an FX are selected, the fader background is coloured purple to indicate that fader positions are showing the 'Sends to' an FX Unit.

- ❗ Only FX units in shared mode can be affected by the 'Send to' levels set here.
- ❗ Outputs cannot be sent to other Outputs so their fader always controls their output level.

The RHS fader is used to control the overall send level to the FX unit. This fader is duplicated by the FX Send Level rotary control in the FX screen when the unit is in shared mode.

11. FX

CONTROL (Shared)

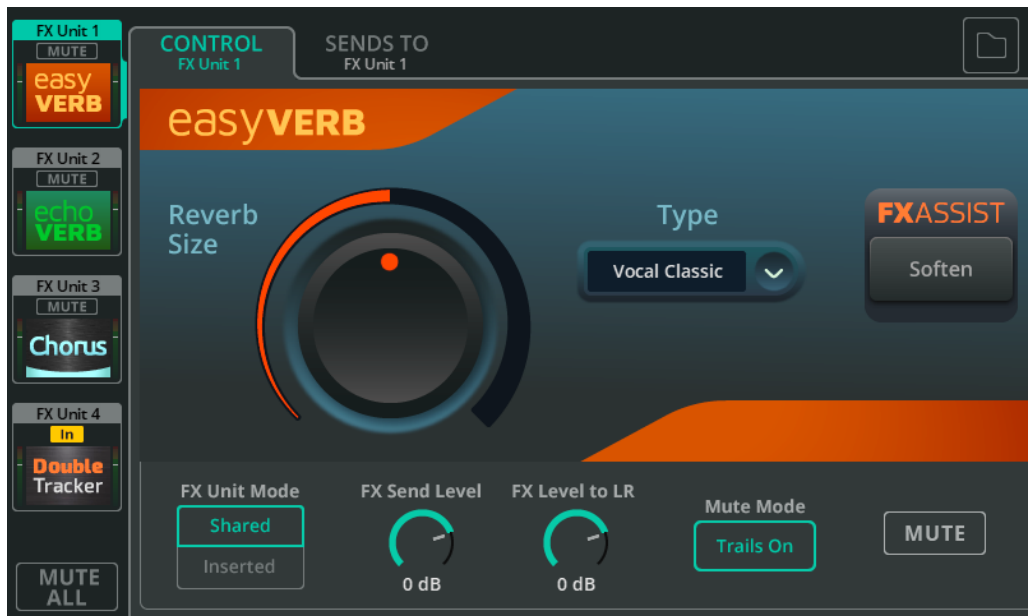

Select an FX unit from the left-hand side to adjust. FX model controls are shown in the main section of the screen.

Library – Use the Library button in the top right to recall different FX models into the selected FX Unit, or to store/recall user presets.

MUTE ALL – Mute all FX Units currently in Shared mode. If all Shared units are currently muted, MUTE ALL can be used to unmute all. MUTE ALL does not affect Inserted FX.

- ⓘ A Soft Key or Footswitch can be assigned to MUTE ALL to make it easy to mute FX in between songs.

Below the FX model controls are the FX Unit controls which are independent of the FX model being used.

FX Unit Mode – ‘Shared’ allows multiple channels to send signal to the FX Unit simultaneously, and for the output of the FX Unit to be sent to Main LR, Outputs or other FX Units at different levels using either the PROCESSING / SENDS screen, or the FADER screen. Shared mode is generally used for reverbs and delays.

‘Inserted’ allows the FX Unit to be used in a single input or output channel, to use a Chorus on a violin for example.

FX Send Level – Adjust the overall level of signal coming into the FX Unit. This is the same control as the fader on the right-hand side of the FADER screen when this FX Unit is selected from ‘Sends to’.

FX Level to LR – Adjust the send level of the FX to the Main LR.

Mute Mode – Set Trails On to hear any reverb or delay trail fade out naturally when muting an FX unit. Set Trails Off to have the FX mute instantly.

MUTE – Mute or unmute the selected FX Unit.

SENDS TO (Shared FX Units only)



When FX units are in Shared mode, use the **SENDS TO** tab to view and adjust channel send levels to the selected FX unit.

These send levels are the same as can be found on each channel individually in the PROCESSING / SENDS screen and can also be controlled using faders when this FX Unit is selected using 'Sends to' in the **FADER** screen.



FX Unit Mode – ‘Shared’ allows multiple channels to send signal to the FX Unit simultaneously, and for the output of the FX Unit to be sent to Main LR, Outputs or other FX Units at different levels from either the PROCESSING / SENDS screen, or in the FADER screen. Shared mode is generally used for reverbs and delays. ‘Inserted’ allows the FX Unit to be used in a single input or output channel, to use a Chorus on a violin for example.

Insert – Select which channel this FX Unit is being used on.

Mix – Adjust the mix from 0% (Dry signal only, no FX audible) to 100% (Wet signal only, only FX audible)

In/Out – Enable or disable the insert. Note that signal from the channel will still arrive at the FX unit input when the FX is switched out, but this is not sent back to the channel so no FX signal will be heard.

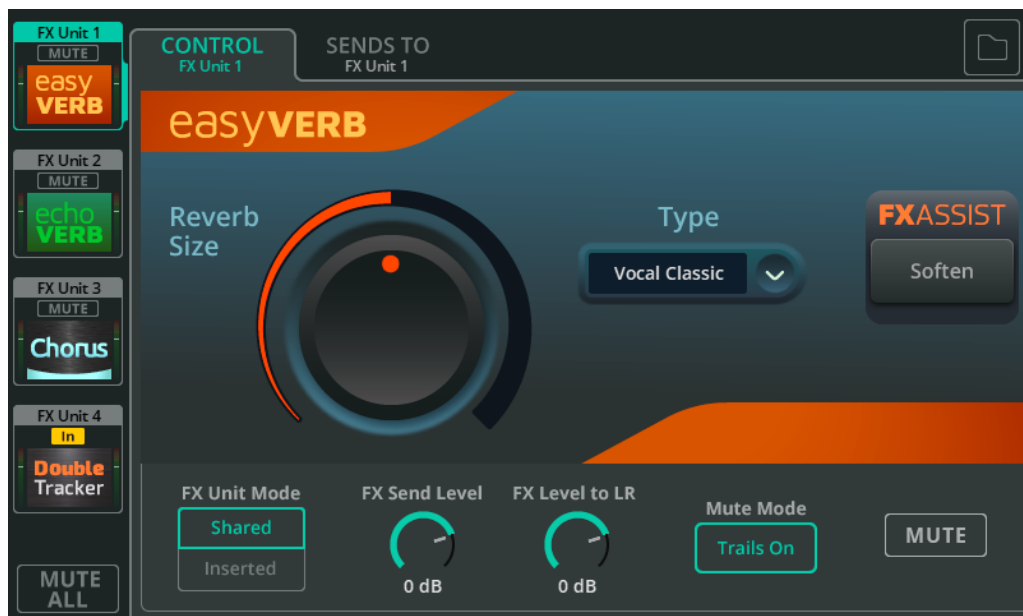

Easy Verb is an instrument/source-centric reverb model.

Type – Select the instrument or source the reverb is being used with.

Reverb Size – Adjust the overall size of the reverb.

FX ASSIST – FX Assist looks at the signal passing through the FX Unit and then makes dynamic adjustments to enhance or improve the sound of the FX. The available FX Assist option will change depending on the Easy Verb Type selected.



Echo Verb is a 3-in-1 FX model which includes an echo, a reverb, and a tap delay.

Echo Level – Adjust the level of the echo effect.

Echo Time – Adjust how quickly the echo occurs.

Size – Adjust the size of the Reverb.

Colour – Adjust the tone of the reverb.

Delay Level – Adjust the level of the delay effect.

Tap Delay Time – Tap on the ms value box to set delay time or select and adjust with the touchscreen rotary (CQ-12T, CQ-18T) or touch and drag (CQ-MixPad).

FX ASSIST - FX Assist looks at the signal passing through the FX Unit and then makes dynamic adjustments to enhance or improve the sound of the FX. One option can be selected at any time, or touch/click the selected option to turn FX Assist Off.



Space Verb includes various reverberant spaces and classic plate reverbs, it's designed to help unify a mix by putting multiple inputs into the same virtual space.

Space – Select an environment or studio reverb type.

Decay Time – Adjust the time that will take for reflections to dissipate.

FX ASSIST - FX Assist looks at the signal passing through the FX Unit and then makes dynamic adjustments to enhance or improve the sound of the FX. One option can be selected at any time, or touch/click the selected option to turn FX Assist Off.



Echo is a simple to use delay unit with a natural tone.

Repeat Rate – Adjust the speed of the repeats.

Intensity – Adjust the level of the repeats feeding back into the echo.

Treble – Cut or boost the level of higher frequencies.

Bass – Cut or boost the level of lower frequencies.



Tap Delay is a single delay which allows the speed of the repeats can be set using taps on screen or using a Soft Key.

Tap Delay Time – Tap multiple times on the ms value box to set delay time or select and adjust with the touchscreen rotary (CQ-12T, CQ-18T) or touch and drag (CQ-MixPad).

Low/High Cut – Cut Low or High frequencies from the sound being repeated.

Thicken – Turn On to make the repeats sound thicker.

Feedback – Adjust the level of the repeats feeding back into the delay.

HF Damping – Adjust the amount of damping on the high frequencies for either a more digital or more analogue sounding delay.

FX ASSIST - FX Assist looks at the signal passing through the FX Unit and then makes dynamic adjustments to enhance or improve the sound of the FX. One option can be selected at any time, or touch/click the selected option to turn FX Assist Off.



Stereo Delay includes two tap delays (left and right) where the speed of repeats can be set independently for each.

Width – Adjust from centre (both delays are heard in the centre) to full width (left is only heard in the left output and right is only heard in the right output).

i Width has no effect if Stereo Delay is inserted into a mono channel.

Left/Right – Tap multiple times on the ms value box to set delay time or select and adjust with the touchscreen rotary (CQ-12T, CQ-18T) or touch and drag (CQ-MixPad).

Link – Link the Left and Right delay times.

Low/High Cut – Cut Low or High frequencies from the sound being repeated.

Ping Pong – Turn On to have the repeats alternate Left/Right.

Feedback – Adjust the level of the repeats feeding back into the delay.

HF Damping – Adjust the amount of damping on the high frequencies for either a more digital or more analogue sounding delay.

FX ASSIST - FX Assist looks at the signal passing through the FX Unit and then makes dynamic adjustments to enhance or improve the sound of the FX. One option can be selected at any time, or touch/click the selected option to turn FX Assist Off.



Beat Delay includes two delays (left and right) where the speed of the repeats is set as a musical division or note value of a BPM value.

Width – Adjust from centre (both delays are heard in the centre) to full width (left is only heard in the left output and right is only heard in the right output).

i Width has no effect if Beat Delay is inserted into a mono channel.

Note Left/Right – Select and adjust with the touchscreen rotary (CQ-12T, CQ-18T) or touch and drag (CQ-MixPad) to set division or note value.

Link – Link the Note Left/Right values.

Low/High Cut – Cut Low or High frequencies from the sound being repeated.

BPM – Tap multiple times on the BPM value to set, or select and adjust with the touchscreen rotary (CQ-12T, CQ-18T) or touch and drag (CQ-MixPad).

Feedback – Adjust the level of the repeats feeding back into the delay.

HF Damping – Adjust the amount of damping on the high frequencies for either a more digital or more analogue sounding delay.

FX ASSIST - FX Assist looks at the signal passing through the FX Unit and then makes dynamic adjustments to enhance or improve the sound of the FX. One option can be selected at any time, or touch/click the selected option to turn FX Assist Off.



The Double Tracker recreates the classic studio effect of recording (or ‘tracking’) the same source multiple times, where slight differences in each recording result in a bigger, thicker sound.

Delay – Adjust the amount of delay between virtual take.

Thickness – Adjust how thick the resulting sound is.

Tracking – Select from DOUBLE (recorded twice) or QUAD (recorded four times)

Width - Select from NARROW (virtual takes are mostly in the centre) or WIDE (different virtual takes are panned left or right).

i Width has no effect if Double Tracker is inserted into a mono channel.



Chorus layers the sound to create an effect similar to a choir or multiple instruments playing the same thing.

Rate – Adjust the modulation speed.

Shape – Select whether modulation is a complete sinusoidal wave or a sinusoidal half-wave.

Intensity – Adjust the amount of modulation being applied.

Pan – Turn On to add stereo width to the sound.

 Pan has no effect if Chorus is inserted into a mono channel.



A Flanger folds the signal back on itself and uses a very fast modulated delay to create a shifting metallic effect.

Speed – Adjust speed of the modulation.

Depth – Adjust the amount of modulation.

Width – Select the stereo spread of the effect.

 Width has no effect if Flanger is inserted into a mono channel.

Regeneration – Send the flanged signal back through the flanger again.

Flange Mode – Set the range of modulation (how wide the frequency sweep is).



The Phaser combines the original signal and a copy of the signal with phase shifting applied at different frequencies. This causes some frequencies to cancel out at the same time as others are reinforced.

Rate – Adjust the speed of the frequency sweep.

Tone – Adjust to select the centre frequency the phaser will work around.

Width – Select to offset left and right outputs and create a wider sound.

 Width has no effect if Phaser is inserted into a mono channel.

Resonance – Adjust how prominent the reinforced frequency is.

Phaser Mode – Set the how wide a range of frequencies the phaser moves through.

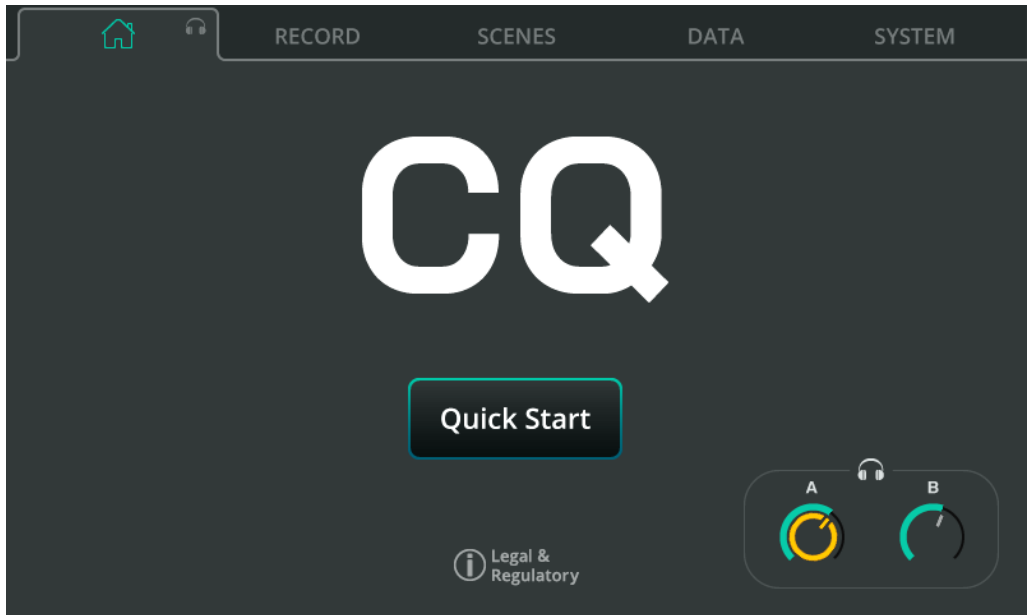

Quick Start – Recall mixer configuration and channel processing for different applications. See the [Quick Start](#) section for more information.

Headphone Control (symbol) – Adjust headphone output level.

 Set the headphone output source in the CONFIG / OUTPUTS screen.

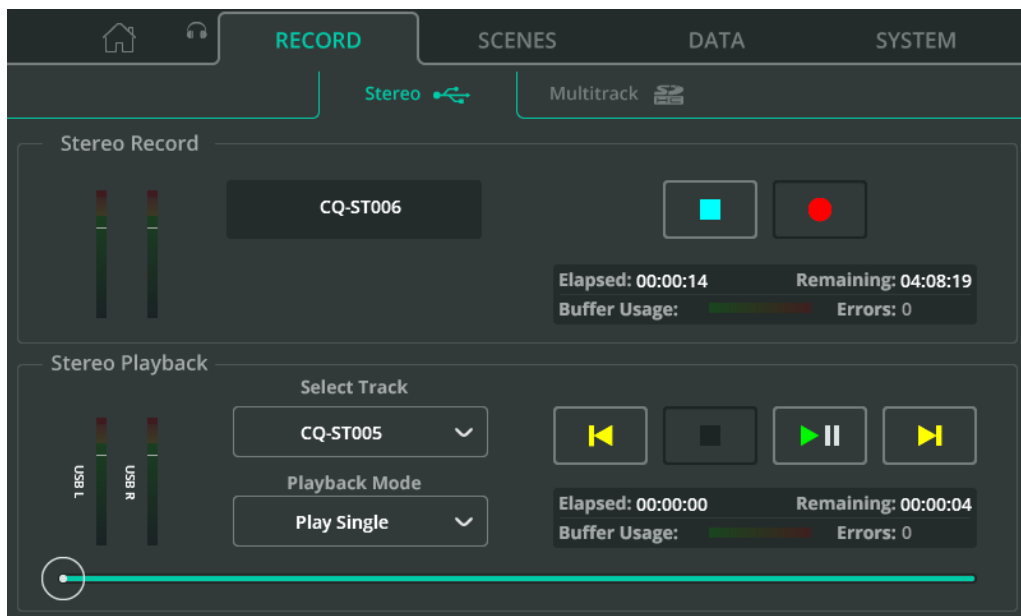

Stereo recording/playback to/from a connected USB drive.

- ⓘ USB-A audio/data and SD recording/playback features utilise the same system resources and cannot be used at the same time.

Stereo Record

The top section of the screen includes level meters for the channels being recorded, recording controls and information (when recording).

- ⓘ Choose the channels assigned to Stereo L/R for recording in the **CONFIG / USB/SD/BT** (symbols) / **USB/SD** screen.

 Press the **Record** button to start recording.

 Press the **Stop** button to stop recording.

Refer to the information box for details such as recording time, remaining time available, and errors (periods of unrecorded data) during the recording.

Stereo recordings are stored in the AHCQ\USBREC folder on the drive.

Stereo Playback

The bottom section of the screen is for playback of audio from USB-A storage.

Select Track - Select the track to be played.

Playback Mode – Options include Play All (and stop), Play Single (and stop), Repeat All (loop through all tracks) and Repeat Single (loop a single track).

Transport Control – Use to Play/Pause, Stop or skip to Previous/Next. Use the circular playback position marker at the very bottom of the screen to jump to a specific point in the track.

Refer to the information box for details such as elapsed/remaining recording time and errors detected during the recording.

Record/Playback Priority

Stereo USB playback signal will be sent to the dedicated stereo USB Input channel and will take priority over signal from USB-B. When stereo recording/playback is in progress, it is not possible to use SD record/playback or store/recall data from USB storage.

Folders, files and formats

The USB device must be formatted to FAT32. This can be carried out using a computer, but it is best to format a drive using the CQ before use.

 Format connected storage in the **HOME / SYSTEM / USB and SD** (symbols) screen.

Recordings are made to the AHCQ\USBREC folder.

Stereo recordings are made to stereo interleaved 24bit uncompressed *.WAV files, at the sample rate set in the **CONFIG / USB/SD/BT / USB/SD** screen.

The CQ can playback stereo files that were recorded on the CQ, or mono/stereo, 44.1/48/96kHz, 16/24bit *.WAV files from the AHCQ\USBREC folder.

Buffer Usage

Buffer usage meters indicate the performance of the connected storage device. If buffers are filled, data will be lost and an error will be counted.

Length of recording

The maximum length of a stereo recording is determined by the maximum file size of 4GB, which equates to approximately 2 hrs at 96kHz or 4 hrs at 48kHz.

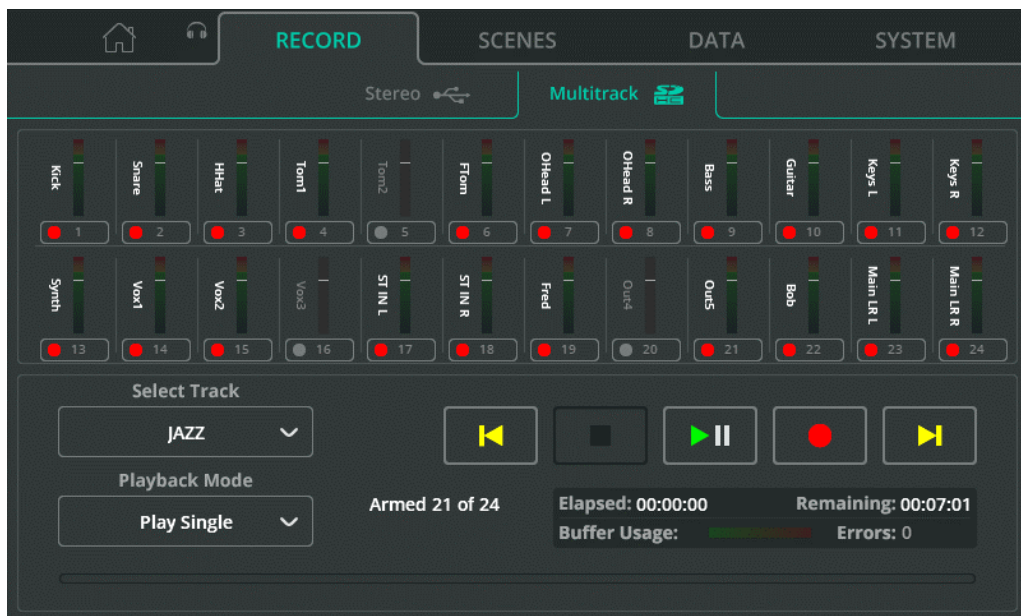

Record or Playback individual signals to and from individual channels using an SDHC card.

- ❗ USB-A audio/data and SD recording/playback features utilise the same system resources and cannot be used at the same time.
- ❗ Meters switch automatically to show either signal being recorded or played.

Set where input channel signal is recorded from (the tap-off point) and assign the last pairs of channels to be recorded in the **CONFIG / USB/SD/BT / USB/SD** screen.

Arm – Use the button under each channel meter to choose whether the channel will be recorded. Armed channels are indicated with a red record symbol. If a channel is armed but cannot be recorded with the current settings or connected SD card, this is indicated with an exclamation mark.

Select Track - Select a multitrack to be played back.

Playback Mode – Options include Play All (and stop), Play Single (and stop), Repeat All (loop through all tracks) and Repeat Single (loop a single track).

Transport Controls – Use to Record, Play/Pause, Stop and skip to Previous/Next. Use the circular playback position marker at the very bottom of the screen to jump to a specific point in the track.

Refer to the information box for details such as elapsed/remaining recording time and errors detected during the recording.

Number of channels

The maximum number of channels which can be recorded depends on the speed of the SD card and the sample rate of the recording.

For best results, use an SDHC card with UHS-I and Class 10 markings.



CQ can record or playback up to 16 channels at 96kHz or up to 24 channels at 48kHz.

‘Armed X of Y’ indicates the number of currently armed channels and total number of channels which *could* be recorded.

Record/Playback Priority

Multitrack playback signal is sent to the digital source for individual channels and takes priority over signal from USB-B. When multitrack recording/playback is in progress, it is not possible to use USB stereo record/playback or store/recall USB data.

Folders, files and formats

The SD card must be formatted in the CQ before use.

 Format connected storage in the **HOME / SYSTEM / USB and SD** (symbols) screen.

Recordings are made to the AHCQ\USBMTK folder. Each recording is stored in its own sub folder as a collection of mono 24bit uncompressed *.WAV files, at the sample rate set in the **CONFIG / USB/SD/BT / USB/SD** screen.

Files are named with the channel number they were recorded from combined with the channel name. e.g. ‘03SnrTop.WAV’. The channel number of the file is the channel it will be routed to when playing back the recording.

Buffer Usage

Buffer usage meters indicate the performance of the connected storage device. If buffers are filled, data will be lost and an error will be counted.

Length of recording

The maximum length of a multitrack recording is determined by the maximum file size of 4GB (for each mono channel recorded), which equates to approximately 4 hrs at 96kHz or 8 hrs at 48kHz.



Scenes are used to store and recall the mix state of the CQ including all processing and send levels. 100 scene slots are available.

 More information can be found in the [Shows, Scenes and Libraries](#) section.

Recall – Replace the current state with the stored state.

Overwrite – Store the current state in the selected scene slot (over the top of a previously stored state).

Store New – Store the current state in the selected scene slot.

Rename – Edit the name of the selected Scene.

Delete – Touch to delete the selected scene.

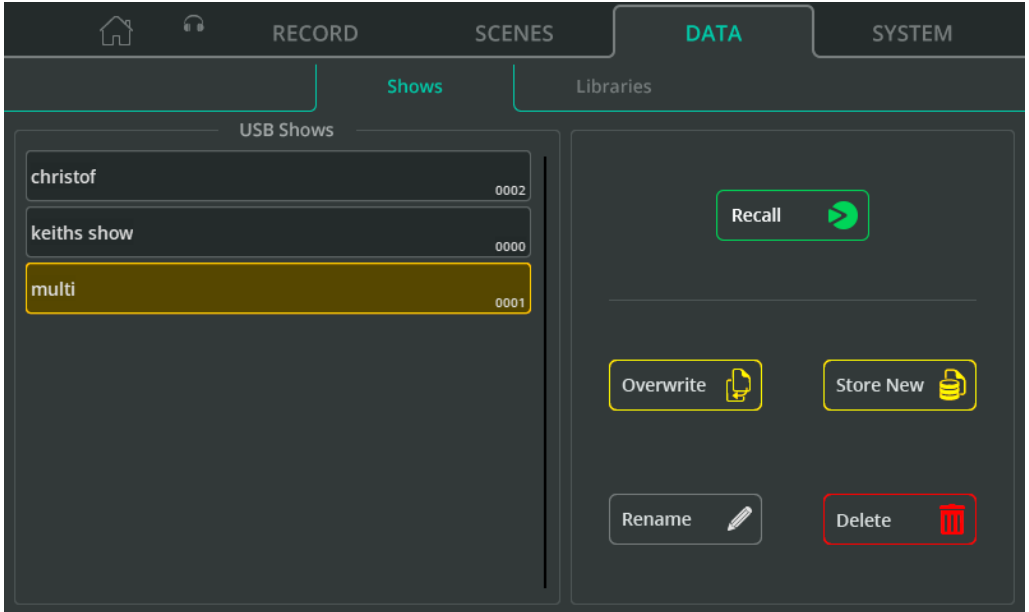

A Show includes the current state of the CQ, along with all stored states (Scenes) and all stored User Libraries. The CQ has one Show loaded at any time, but can store or recall a show to/from a connected USB drive.

Recall – Replace the current Show (state, Scenes and Libraries) on the CQ with the stored Show.

Overwrite – Store the current Show in place of the selected Show on the drive.

Store New – Store the current Show as a new Show on the drive.

Rename – Edit the name of the selected Show on the drive.

Delete – Remove the selected Show from the drive.

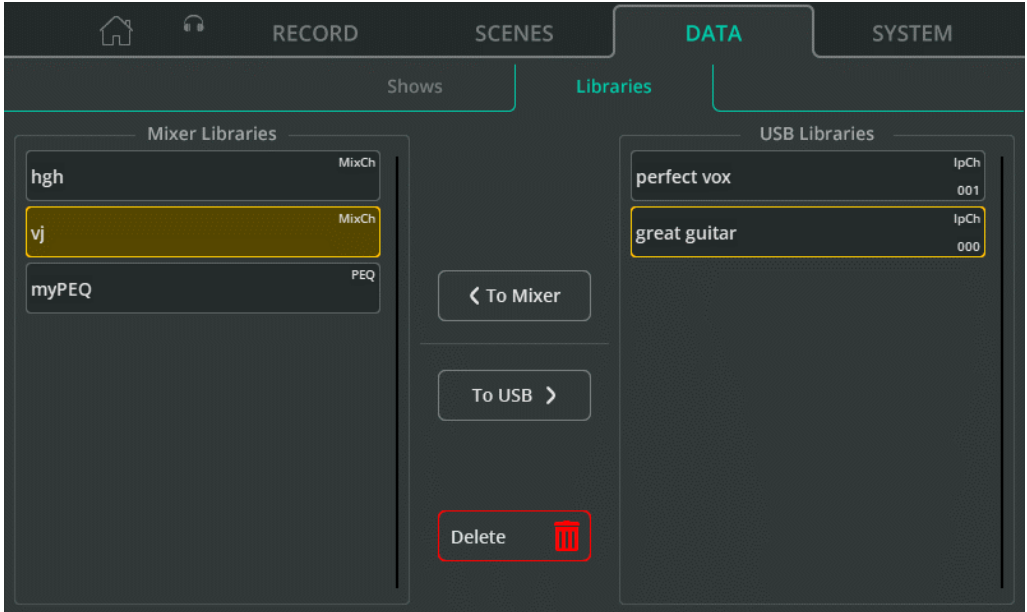

The CQ can have up to 128 User libraries stored at any time. These are included when storing or recalling an entire Show, but can also be stored or recalled individually using a USB drive.

‘Mixer Libraries’ lists all the Libraries in the Show currently loaded on the CQ. ‘USB Libraries’ lists all the Libraries stored in the AHCQ\LIBRARY folder of the connected USB drive.

To Mixer – Copy the Library selected (outlined yellow) in the USB Libraries list to Mixer Libraries.

To USB – Copy the Library selected (outlined yellow) in the Mixer Libraries list to USB Libraries.

Delete – Delete the Library that was last selected (highlighted yellow)

The screenshot shows a dark-themed user interface for system information. At the top, there are navigation icons for home, headphones, RECORD, SCENES, DATA, and SYSTEM (highlighted in green). Below this is a sub-menu with 'Info' (highlighted), a USB icon, a storage icon, 'Firmware', 'Meters', and 'Preferences'. The main content area displays a list of system parameters and their values:

System Status:	✓
DDR Calibration:	RU:0 RO:0 FF:0 FE:1 C1:1 C0:1 PASS
Core temp:	71.24 C (Max: 71.86 C, Min: 58.32 C)
Core voltage:	0.996 V (Max: 1.000 V, Min: 0.995 V)
DAC temp:	63.00 C (Max: 64.00 C, Min: 57.00 C)
FX temp:	74.44 C (Max: 74.93 C, Min: 56.85 C)
Fan speed:	1123 RPM
Fan PWM:	34
TFT PWM:	100
MAC:	00:04:c4:09:d2:04
Firmware Version:	1.1.0 r3553
Build:	Release
IP Address:	192.168.2.1
Active Image:	1
Bootloader Version:	3078
FPGA:	6/4/23/ 13:55:27
OS state:	1
Audio Board:	Type 2

Displays diagnostic information about the unit.

Core temp, **Core voltage**, **DAC temp** and **FX temp** all include Max and Min values. Note that these are not the maximum and minimum ranges of operation, but rather the maximum and minimum values that have been recorded since the unit was last powered on.



Displays details on any connected USB drive and/or SD Card

Format – Select to Format the connected USB Drive or SD Card. This will delete all data, set the file system to FAT32 and add folders required for use with CQ for audio recording (USB/SD) and data storage (USB).

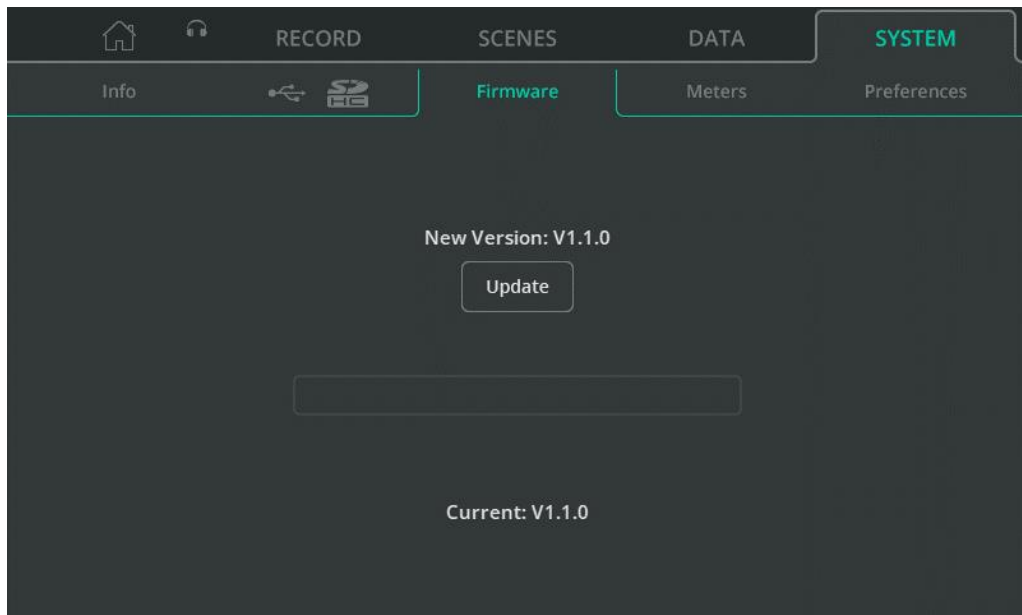

Shows the firmware currently installed on the unit at the bottom of the screen along with the firmware found on a connected USB drive at the top.

Update – Begin the firmware update process.

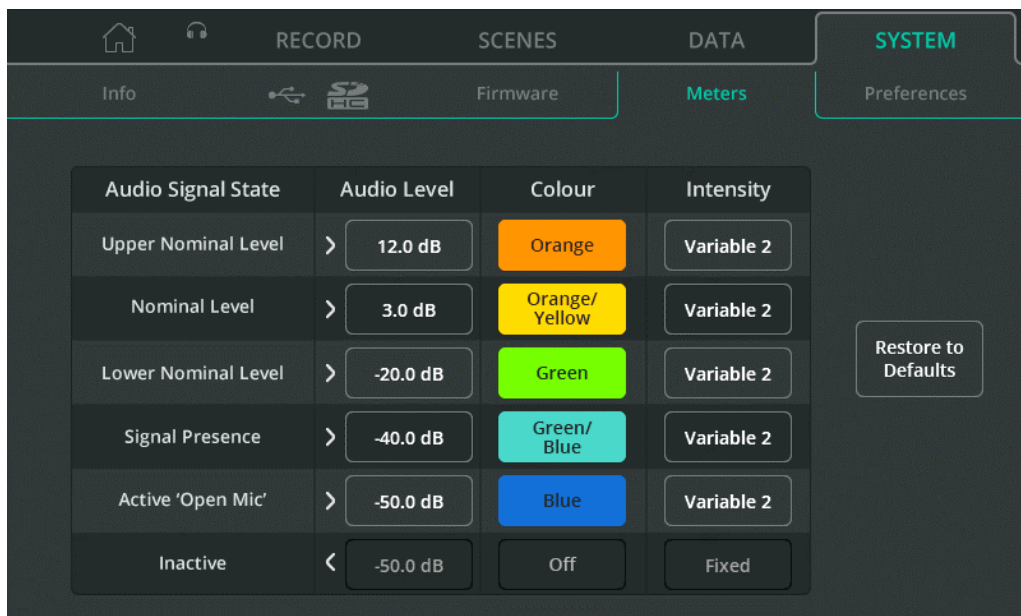

Chromatic meters are displayed in the CONFIG screen, on Quick Channels and there is one on the CQ-20B which can be set for use with any input or output channel.

They use colour and brightness to express signal level in a smaller space and can also show much lower levels than standard meters (from -72dB), so a source can often be seen before being heard. They can be customised, either to show colours that are easy for the user to distinguish between, or to show when particular signal levels are reached.

Audio Level – Adjust the Audio Level for each Audio Signal State.

Colour – Assign a colour to each Audio Signal State.

Intensity – Select between a Fixed or Variable intensity.

Fixed = Meter switches instantly between states.

Variable 1 = Meter changes close to the endpoints of its range.

Variable 2 = Meter changes across its whole range

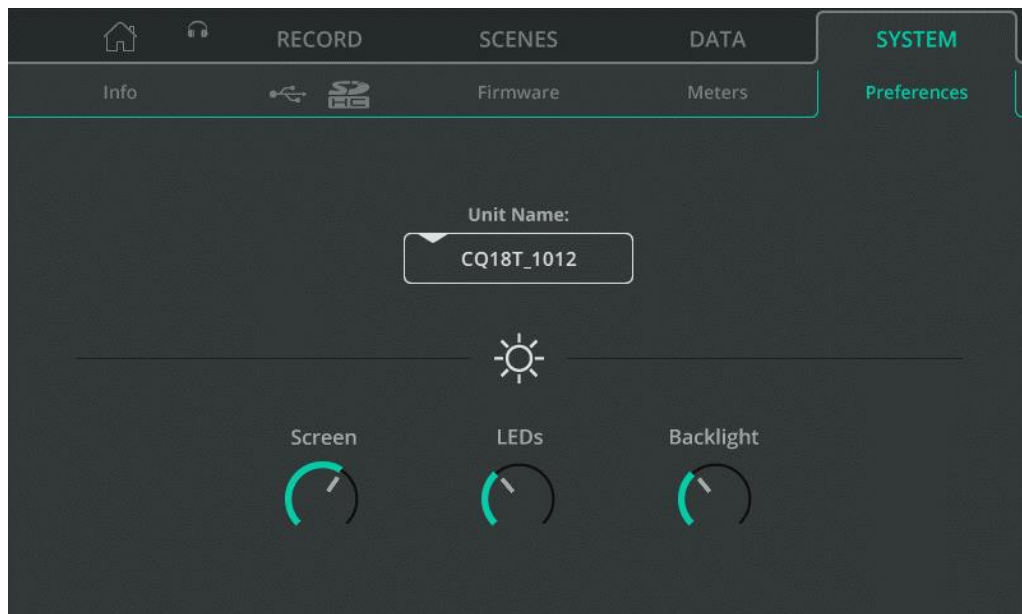

Unit Name – Change the name of the unit, as displayed in the ‘Choose Unit’ connection screen when using remote control apps (CQ-MixPad, CQ4You)

Unit name and the Wi-Fi Access Point network name (SSID) on the CQ-18T and CQ-20B are the same by default, but can be renamed independently.

Screen – Adjust the brightness of the touchscreen.

LEDs – Adjust the brightness of selected Screen key and active Soft Keys.

Backlight – Adjust the brightness of the Screen and Soft Key backlight.

13. Resets

CQ-12T and CQ-18T Factory Reset

1. Start with the power off.
2. Hold '**HOME**' and Soft Key '**1**' whilst powering on the unit.
3. Continue to hold until the unit has fully booted.

 A Factory reset will clear all stored data including Scenes and Libraries and reset all preferences and network settings to their default values. Before carrying out a factory reset, it is best practice to [store a Show](#) which can be recalled again later if needed.

CQ-20B Factory and Network Only Resets

1. Power on the unit and allow to boot.
2. If the network connection has already been set up and the system boots normally, the '**CM**' LED will illuminate GREEN ● by default, or behave as it has been set to in the system preferences.
If the '**CM**' LED flashes BLUE ● or YELLOW ● then the CQ has already been reset and a network reset is not needed.
3. Use a small, pointed but not sharp object (e.g. a pencil) to press and hold the '**RESET**' button, the '**CM**' LED will illuminate WHITE ○, hold the button down for 2 seconds and release to access the reset menu.
4. Press the button momentarily (for less than 2 seconds) to cycle through 3 reset options:
 - a. '**CM**' LED lights RED ● = Factory reset
All mixer parameters will be set to default values.
All data stored on the CQ (including scenes and libraries) will be deleted.
Wi-Fi and Ethernet network settings will be set to default values and method of connection must be re-selected.
 - b. '**CM**' LED lights BLUE ● = Wi-Fi reset
Wi-Fi settings set to default values and WiFi connection is active.
 - c. '**CM**' LED lights YELLOW ● = Ethernet reset
Ethernet settings set to default values and Ethernet connection is active.
5. With the '**CM**' LED showing the colour matching the reset to be performed, press and hold the '**RESET**' button for 2 seconds to action the reset.

 To exit the reset menu, do not interact with the '**RESET**' button for 10 seconds.

Default Network Settings

On first boot or after a reset, network defaults are as follows:

Wi-Fi (CQ-18T, CQ-20B)

- SSID is **Visible**.
- SSID is [**CQ18T_XXXX** or **CQ20B_XXXX**] where XXXX are the last 4 digits of the serial number.
- Security is set to '**OPEN**' (no password is required to connect a device).
- Password is set to '**DefaultPassword**'.

i This will be the password if Security is switched to '**WPA2**' and changes are applied without editing the password first.

- Country is set to '**World-Wide**'.
- Channel is set to '**AUTO**'.

Ethernet

- IP Settings are '**Automatic**'
- The unit will be assigned an IP address by a DHCP server (e.g. a connected router), devices on the same network and in the same network range running CQ-MixPad can then connect to the unit.
- If no address is provided, the CQ will automatically assign itself a local address. This allows for a direct connection to a computer using a network cable.

Ethernet (if IP Settings is switched to Manual without other changes)

- IP Address **192.168.1.62**
- Gateway **192.168.1.254**
- Subnet **24 (255.255.255.0)**

14. System Block Diagram

CQ SYSTEM BLOCK DIAGRAM

Firmware V1.1

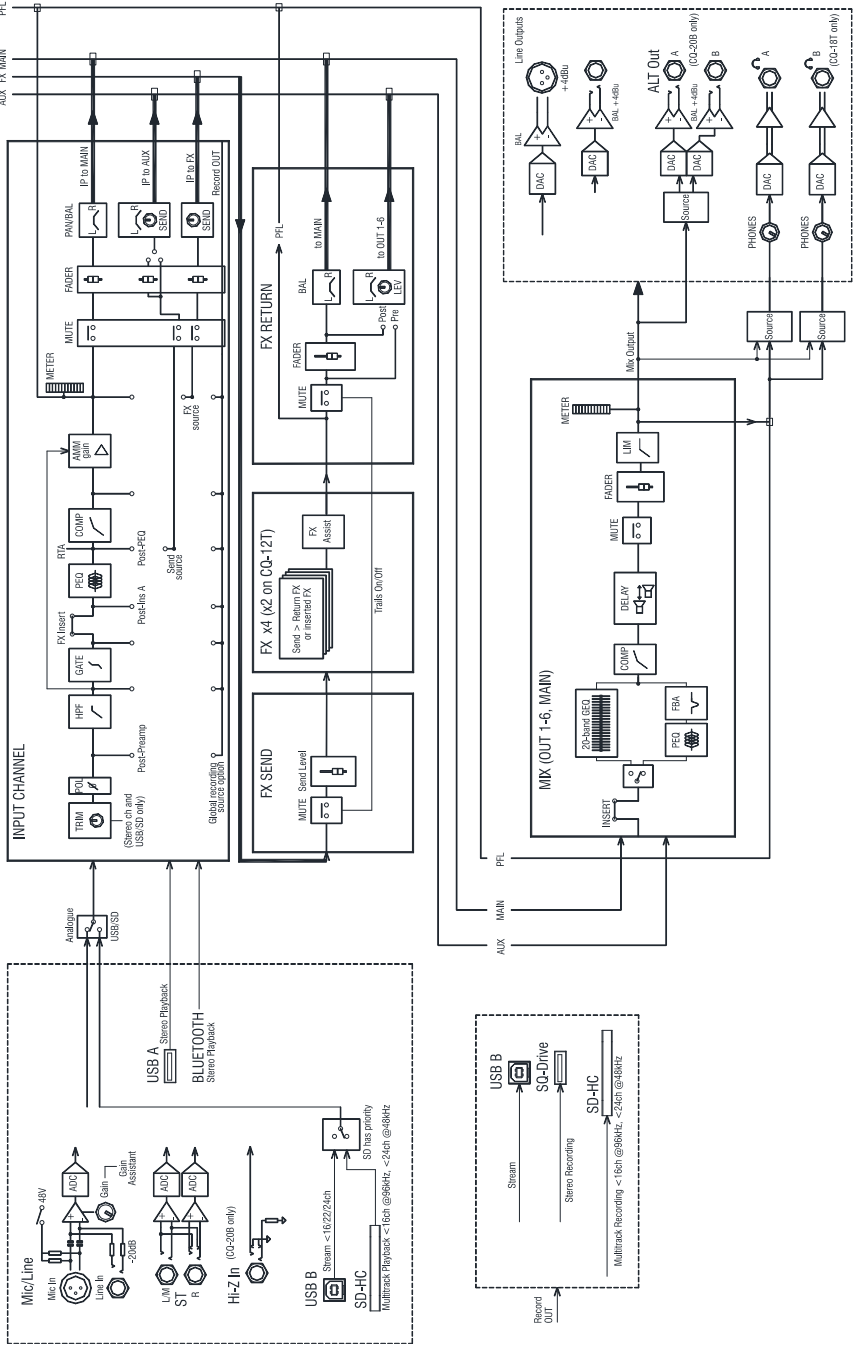

15. Specifications

Mic/Line Inputs	Balanced XLR, Balanced XLR/TRS Combi, fully recallable preamp
Input Sensitivity	-60 to +0dBu
Line Inputs (Combi Sockets)	-20dB Pad (Fixed)
Hi-Z Inputs (CQ-20B 15&16)	Relay switched, 1M Ohm impedance, 0 to +40dB gain
Analogue Gain	0dB to +60dB, 1dB steps
Maximum Input Level	+17dBu (XLR), +30dBu (TRS)
Input Impedance	>1.5k Ω (XLR), >10k Ω (TRS)
THD+N, Unity gain 0dB	0.002% -92dBu (20Hz-20kHz, USB soundcard, @0dBu 1kHz)
THD+N, Mid gain +30dB	0.004% -88dBu (20Hz-20kHz, USB soundcard, @-30dBu 1kHz)
Phantom Power	+48V (+3V / -2V)
Stereo Line Inputs	
Stereo Line Input Connection	Balanced, 1/4" TRS Jack, Normalled
Input Sensitivity	Nominal +4dBu
Trim	+/-24dB
Maximum Input Level	+21dBu
Input Impedance	>10k Ω
Outputs	
Main LR	Balanced, XLR
Outputs 1-6	Balanced, 1/4" TRS Jack (CQ-18T, CQ-12T), XLR (CQ-20B)
Output Impedance	<75 Ω
Nominal Output	+4dBu = 0dB meter reading
Maximum Output Level	+22dBu
Residual Output Noise	-88dBu (muted, 20Hz-20kHz)

System	Measured balanced XLR in to XLR out, 0dB gain, 0dBu input
Dynamic Range	110 dB
Frequency Response	+0/-0.5dB 20Hz to 20kHz
Headroom	+18dB
Internal operating Level	0dBu
THD+N, Mic routed to Main L/R Out	+10dBu input, 0dB system gain, 0.003%, -92dB (Relative, 20-20kHz)
dBFS Alignment	+18dBu = 0dBFS (+22dBu at XLR output)
Meter Calibration	0dB meter = -18dBFS (+4dBu at XLR out)
Sampling Rate	96kHz
Bit Depth	Uses XCVI core custom bit widths in algorithms, up to 96bits
Latency	<0.7ms, Local Mic Input to Main L/R, with all processing in or out
Operating Temperature Range	0°C to 40°C (32°F to 104°F)
Wi-Fi Access Point	802.11 a/b/g/n/ac (dual band, auto channel)
Bluetooth	4.1
USB-A	
Stereo Record	48/96 kHz, 24 bit WAV format. Patchable from Outputs, ST in, or FX Units
Stereo Playback	44.1/48/96 kHz, 16/24 bit, Mono/Stereo WAV files.
USB-B	USB 2.0, Core Audio compliant, ASIO/WDM for Windows, 48/96 kHz , 24 bit
Send (upstream)	CQ-12T 16 channels, CQ-18T and CQ-20B 24 channels
Return (downstream)	CQ-12T 16 channels, CQ-18T and CQ-20B 24 channels*
SD Card	SDHC, 32 GB, UHS-I Speed class 10 for maximum channels
Multitrack Record (Max)	16 channels @ 96kHz or 24 channels @ 48 kHz (CQ-18T, CQ-20B)
Multitrack Playback (Max)	16 channels @ 96kHz or 22 channels (CQ-18T), 24 channels (CQ-20B) @ 48 kHz

CQ-12T	
As Used	291 x 242 x 89 mm (11.4" x 9.5" x 3.5")
Packed in shipping box	370 x 305 x 190 mm (14.6" x 12" x 7.5")
Unpacked weight	2.4 kg (5.3 lbs)
Packed weight	3.2 kg (7.05 lbs)
Mains Power	+12V DC 5.4A (centre positive) (100-240V AC, 50/60Hz PSU supplied)
Max Power Consumption	35W
CQ-18T	
As Used	346 x 242 x 89 mm (13.6" x 9.5" x 3.5")
Packed in shipping box	430 x 310 x 200 mm (16.9" x 12.2" x 7.9")
Unpacked weight	3 kg (6.6 lbs)
Packed weight	3.8 kg (8.4 lbs)
Mains Power	+12V DC 5.4A (centre positive) (100-240V AC, 50/60Hz PSU supplied)
Max Power Consumption	45W
CQ-20B	
As Used	372 x 154 x 134 mm (14.7" x 6.1" x 5.3")
Packed in shipping box	450 x 260 x 250 mm (17.7" x 10.2" x 9.8")
Unpacked weight	2.6 kg (5.8 lbs)
Packed weight	3.3 kg (7.3 lbs)
Mains Power	100-240V AC, 50/60Hz, IEC
Max Power Consumption	45W

16. Warranty Information

Limited One Year Manufacturer's Warranty

Allen & Heath warrants the Allen & Heath -branded hardware product and accessories contained in the original packaging ("Allen & Heath Product") against defects in materials and workmanship when used in accordance with Allen & Heath's user manuals, technical specifications and other Allen & Heath product published guidelines for a period of ONE (1) YEAR from the date of original purchase by the end-user purchaser ("Warranty Period").

This warranty does not apply to any non-Allen & Heath branded hardware products or any software, even if packaged or sold with Allen & Heath hardware.

Please refer to the licensing agreement accompanying the software for details of your rights with respect to the use of software/firmware ("EULA").

Details of the EULA, warranty policy and other useful information can be found on the Allen & Heath website: www.allen-heath.com/legal.

Repair or replacement under the terms of the warranty does not provide right to extension or renewal of the warranty period. Repair or direct replacement of the product under the terms of this warranty may be fulfilled with functionally equivalent service exchange units.

This warranty is not transferable. This warranty will be the purchaser's sole and exclusive remedy and neither Allen & Heath nor its approved service centres shall be liable for any incidental or consequential damages or breach of any express or implied warranty of this product.

Conditions of Warranty

The equipment has not been subject to misuse either intended or accidental, neglect, or alteration other than as described in the User Guide or Service Manual, or approved by Allen & Heath. The warranty does not cover fader wear and tear.

Any necessary adjustment, alteration or repair has been carried out by an authorised Allen & Heath distributor or agent. The defective unit is to be returned carriage prepaid to the place of purchase, an authorised Allen & Heath distributor or agent with proof of purchase. Please discuss this with the distributor or the agent before shipping. Units returned should be packed in the original carton to avoid transit damage.

DISCLAIMER: Allen & Heath shall not be liable for the loss of any saved/stored data in products that are either repaired or replaced.

Check with your Allen & Heath distributor or agent for any additional warranty information which may apply. If further assistance is required, please contact Allen & Heath Ltd.

Any changes or modifications to the equipment not approved by Allen & Heath could void the compliance of the product and therefore the user's authority to operate it.

CQ User Guide, Firmware V1.1.0, issue 1.
Copyright © 2023 Allen & Heath. All rights reserved.

ALLEN & HEATH

Allen & Heath Limited, Kernick Industrial Estate, Penryn, Cornwall, TR10 9LU, UK

www.allen-heath.com